

Interaction Diagram – Barbell Concrete Shear Wall Unsymmetrical Boundary Elements

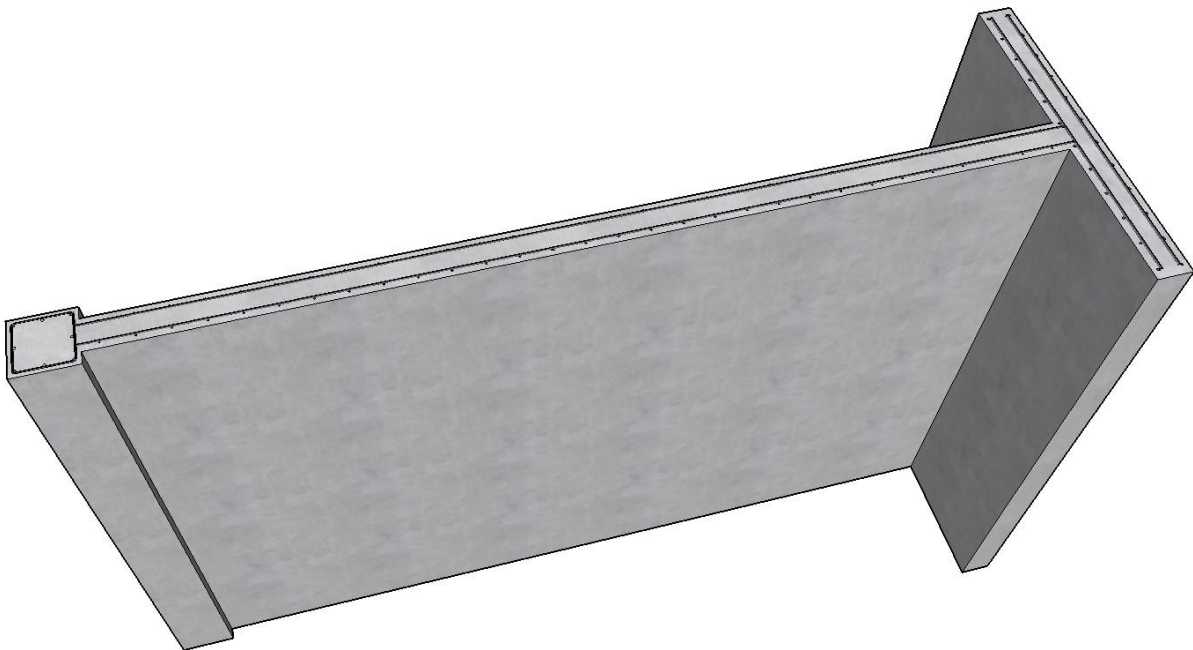

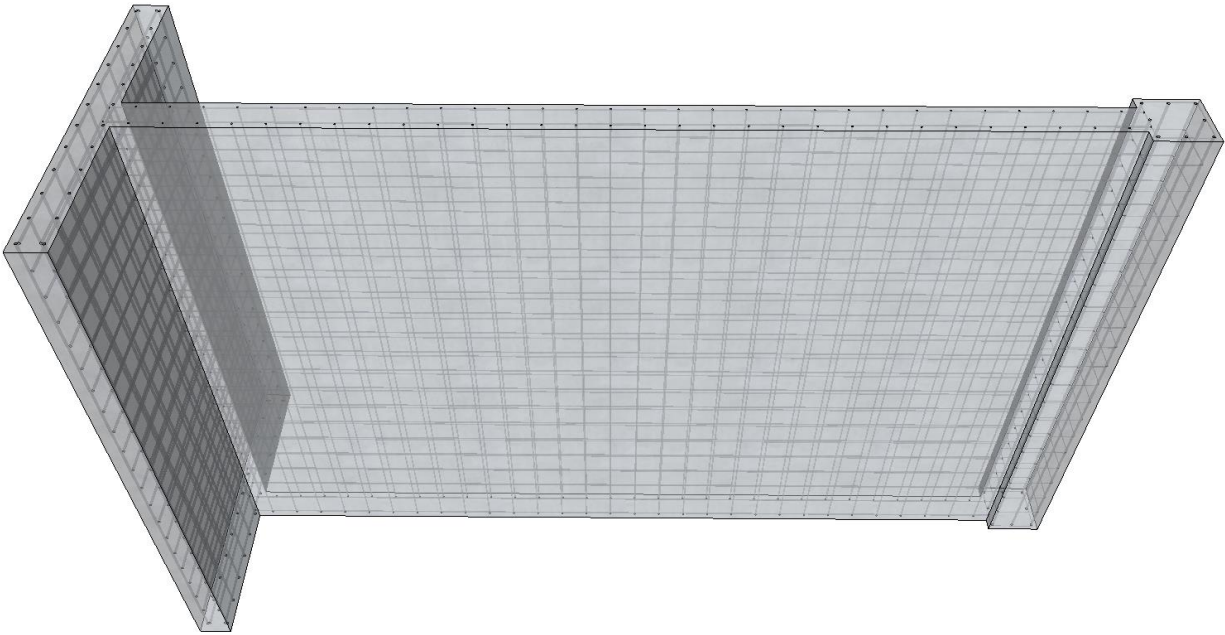
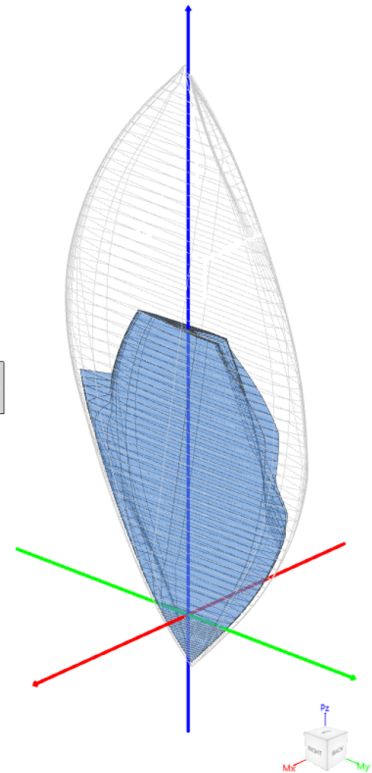
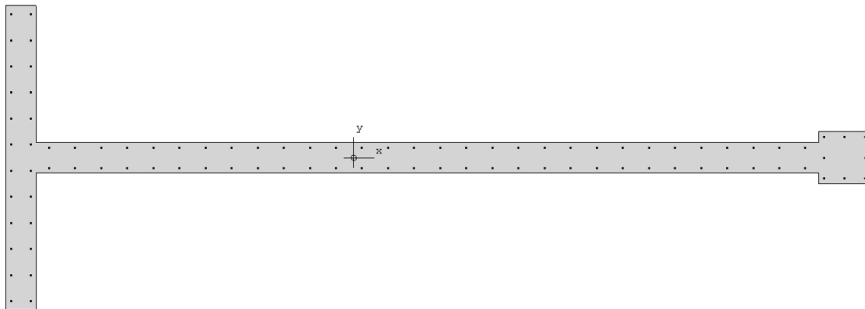
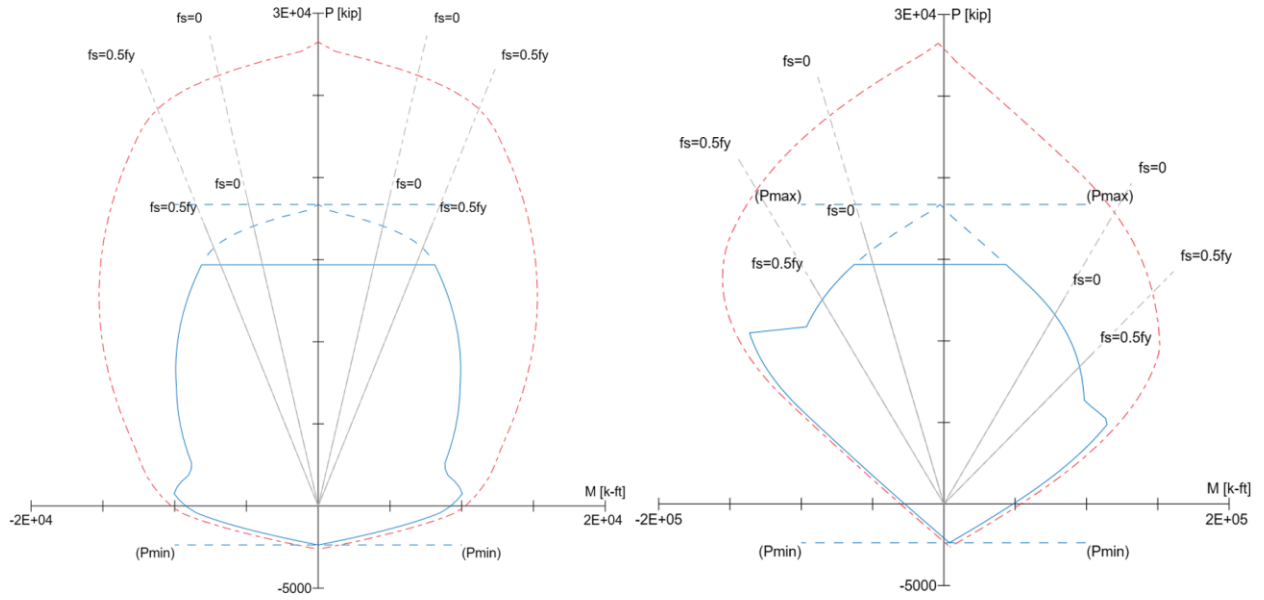

Interaction Diagram – Barbell Concrete Shear Wall Unsymmetrical Boundary Elements

Investigate the capacity for the irregular T-shaped concrete shear wall acting as a retaining wall for a deep underground parking garage facility in a mixed-use multistory building. The T-shaped formation comprises the basement retaining wall (Tee flange), the stem serving as the shear wall (Tee web) and, the first building column of the standard 30' x 30' bays (Tee bottom). Develop a P-M diagram by determining seven control points on the interaction diagram and compare the calculated values with exact values from the complete interaction diagram generated by [spColumn](#) engineering software program from [StructurePoint](#). The initial reinforcement bar size and arrangement in the shear wall were obtained assuming a light reinforcement ratio of 0.60% with a final as-designed reinforcement ratio of 2.2%.

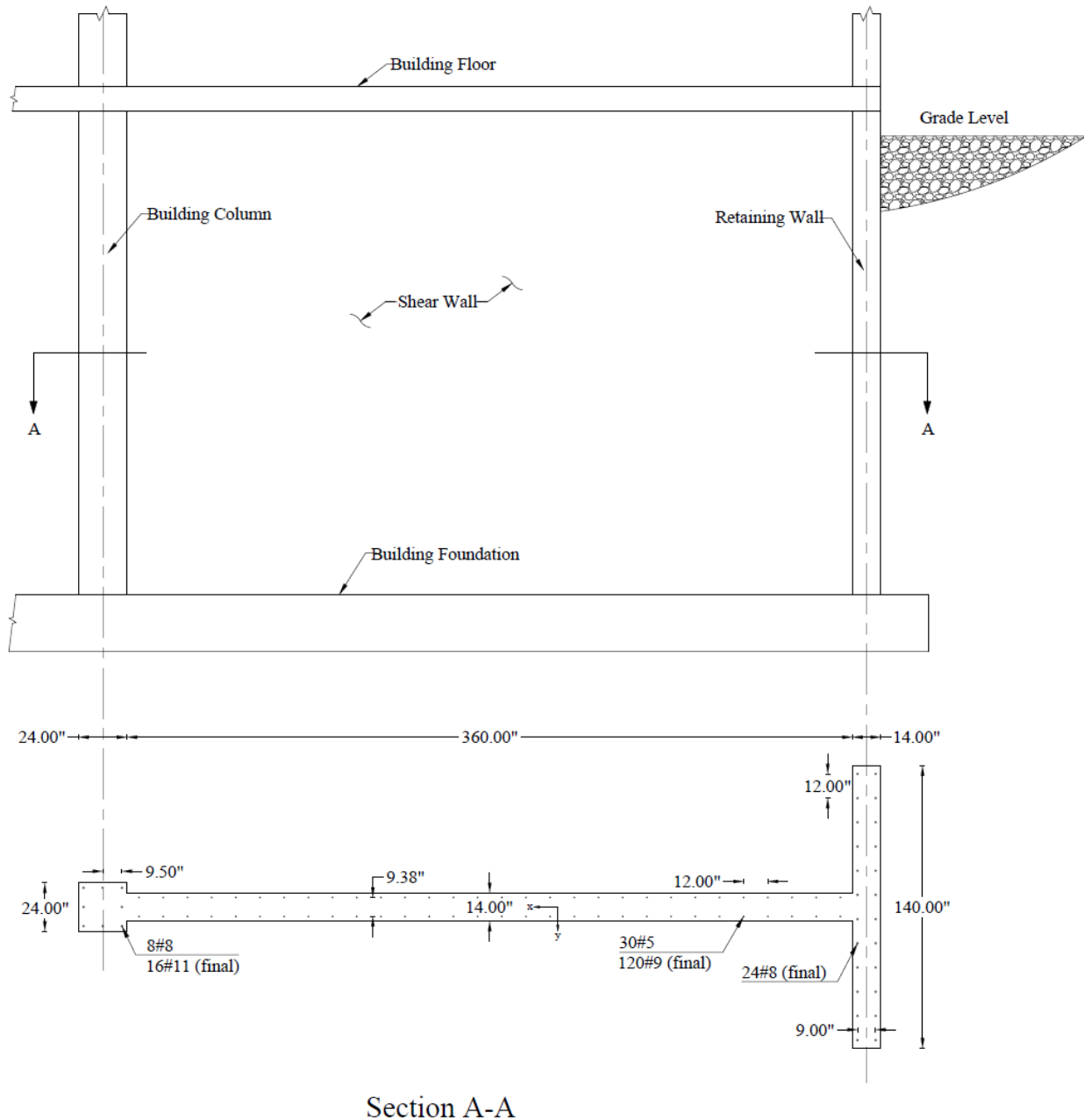

Figure 1 – Reinforced Concrete Shear Wall Cross-Section

Contents

Control Points (Moment Rotation about the Negative Y-Axis).....	6
1. Maximum Compression	6
1.1. Nominal axial compressive strength	6
1.2. Factored axial compressive strength	8
1.3. Maximum (allowable) factored axial compressive strength.....	8
2. Bar Stress Near Tension Face Equal to Zero, ($\epsilon_s = f_s = 0$).....	9
2.1. c , a , and strains in the reinforcement	10
2.2. Forces in the concrete and steel.....	10
2.3. ϕP_n and ϕM_n	11
3. Bar Stress Near Tension Face Equal to $0.5 f_y$, ($f_s = 0.5 f_y$).....	13
3.1. c , a , and strains in the reinforcement	14
3.2. Forces in the concrete and steel.....	14
3.3. ϕP_n and ϕM_n	15
4. Bar Stress Near Tension Face Equal to f_y , ($f_s = f_y$).....	17
4.1. c , a , and strains in the reinforcement	18
4.2. Forces in the concrete and steel.....	18
4.3. ϕP_n and ϕM_n	19
5. Bar Strain Near Tension Face Equal to 0.005 in./in., ($\epsilon_s = 0.005$ in./in.)	21
5.1. c , a , and strains in the reinforcement	22
5.2. Forces in the concrete and steel.....	22
5.3. ϕP_n and ϕM_n	23
6. Pure Bending.....	25
6.1. c , a , and strains in the reinforcement	25
6.2. Forces in the concrete and steel.....	25
6.3. ϕP_n and ϕM_n	26
7. Maximum Tension	28
7.1. P_{nt} and ϕP_{nt}	28
7.2. M_n and ϕM_n	28
Control Points (Moment Rotation about the Positive Y-Axis).....	30
8. Column Interaction Diagram - spColumn Software.....	32
9. Summary and Comparison of Design Results.....	45
10. Conclusions & Observations	46

Code

Building Code Requirements for Structural Concrete (ACI 318-14) and Commentary (ACI 318R-14)

References

[spColumn Engineering Software Program Manual v10.00](#), STRUCTUREPOINT, 2021

“[Interaction Diagram - Tied Reinforced Concrete Column \(ACI 318-14\)](#)” Example, STRUCTUREPOINT, 2017

Design Data

$$f_c' = 4000 \text{ psi}$$

$$f_y = 60,000 \text{ psi}$$

Clear Cover = 2 in.

The reinforcement size and location selected for this shear wall are shown in Figure 1. Detailed bar and concrete shape data are tabulated below.

Layer	A_s/bar , in ²	# of bars	d, in
1	0.79	12	2.5
2	0.79	12	11.5
3	0.31	2	20.0
4	0.31	2	32.0
5	0.31	2	44.0
6	0.31	2	56.0
7	0.31	2	68.0
8	0.31	2	80.0
9	0.31	2	92.0
10	0.31	2	104.0
11	0.31	2	116.0
12	0.31	2	128.0
13	0.31	2	140.0
14	0.31	2	152.0
15	0.31	2	164.0
16	0.31	2	176.0
17	0.31	2	188.0
18	0.31	2	200.0
19	0.31	2	212.0
20	0.31	2	224.0
21	0.31	2	236.0
22	0.31	2	248.0
23	0.31	2	260.0
24	0.31	2	272.0
25	0.31	2	284.0
26	0.31	2	296.0
27	0.31	2	308.0
28	0.31	2	320.0
29	0.31	2	332.0
30	0.31	2	344.0
31	0.31	2	356.0
32	0.31	2	368.0
33	0.79	3	376.5
34	0.79	2	386.0
35	0.79	3	395.5

Part	h, in	b, in	A_c/part , in ²
1	14.0	140.0	1960.0
2	360.0	14.0	5040.0
3	24.0	24.0	576.0
$A_{c(\text{total})}$, in ²			7576.0

Note: Layer 1 and 2 are in the retaining wall section (Tee flange)

Layer 33, 34, and 35 are in the building column section (Tee bottom)

The rest of the layers are in the shear wall section

Solution

Use the traditional detailed approach to generate the interaction diagram for the concrete wall section shown above by determining the following seven control points for positive and negative moment about the y-axis:

Point 1: Maximum compression

Point 2: Bar stress near tension face equal to zero, ($f_s = 0$)

Point 3: Bar stress near tension face equal to $0.5 f_y$ ($f_s = 0.5 f_y$)

Point 4: Bar stress near tension face equal to f_y ($f_s = f_y$)

Point 5: Bar strain near tension face equal to 0.005

Point 6: Pure bending

Point 7: Maximum tension

Several terms are used to facilitate the following calculations:

A_g = gross area of concrete section, in².

\bar{x} = geometric centroid location along the x-axis, in.

P_o = nominal axial compressive strength, kip

ϕP_o = factored axial compressive strength, kip

ϕM_o = moment strength associated with the factored axial compressive strength, kip-ft

$\phi P_{n,max}$ = maximum (allowable) factored axial compressive strength, kip

c = distance from the fiber of maximum compressive strain to the neutral axis, in.

a = depth of equivalent rectangular stress block, in.

A_p = gross area of equivalent rectangular stress block, in².

\bar{x}_p = plastic centroid location along the x-axis, in.

C_c = compression force in equivalent rectangular stress block, kip

$\varepsilon_{s,i}$ = strain value in reinforcement layer i , in./in.

$C_{s,i}$ = compression force in reinforcement layer i , kip

$T_{s,i}$ = tension force in reinforcement layer i , kip

A complete nominal and design interaction (P-M) diagrams are shown in Figure 2 along with the key control points. The observations on the P-M diagram of an irregular wall or column sections are summarized as follows:

1. The interaction diagram for an irregular section is tilted provided that the moments are taken about the geometric centroid. This is due to the unsymmetrical geometry and/or reinforcement configuration.
2. The calculation of an interaction diagram for an irregular section follows the same procedure as a regular section, except at uniform compressive and uniform tensile strains (i.e., points 1.1-1.2 for compression and points 7.1-7.2 for tension). In these cases, the moment values become non zero, unlike the symmetrical sections, due to unsymmetrical reinforcement configuration causing a moment of steel forces about the centroid.
3. The left side of the P-M diagram shows elevated axial load capacities for all control points owing to the increased area of the concrete compression block mainly because the large wall flange is in compression including a larger reinforcement area in the flange.
4. In large cross sections with irregular geometries and/or reinforcement configurations, very high strains may be reached in the reinforcement near the tension face. This condition will be prominent in the range between pure bending control point and maximum tension control point (the strain value at maximum tension point is assumed as infinity). This may be exacerbated by low reinforcement amounts further lowering neutral axis depth which in turn results in a further increase in tensile strains at reinforcement. In such cases, engineers may review the amount of steel and revise as required to achieve what they deem reasonable to balance the steel ratio with the steel strain in tension as will be seen in this example.

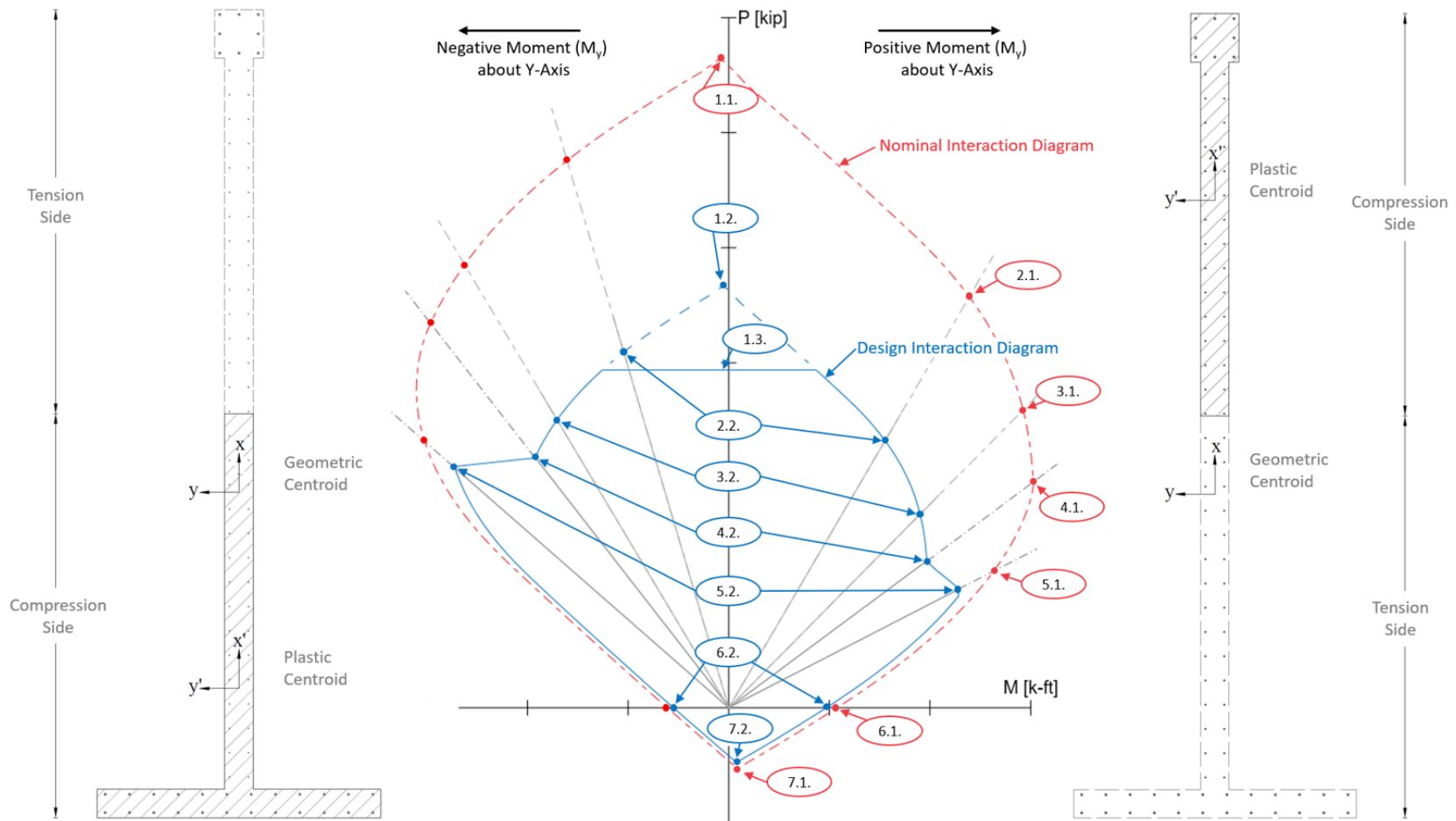

- 1.2. Maximum Factored Axial Strength in Compression
- 1.3. Allowable Factored Axial Strength in Compression ($\phi P_{n,max}$)
- 2.2. Factored Control Point at Zero Stress in Tension Reinforcement
- 3.2. Factored Control Point at Tension Reinforcement Stress = $0.5f_y$
- 4.2. Factored Control Point at Tension Reinforcement Stress = f_y
- 5.2. Factored Control Point at Tension Reinforcement Stress = 0.005 in./in.
- 6.2. Factored Control Point at Pure Bending
- 7.2. Maximum Factored Axial Strength in Tension

- 1.1. Maximum Nominal Axial Strength in Compression (P_o)
- 2.1. Nominal Control Point at Zero Stress in Tension Reinforcement
- 3.1. Nominal Control Point at Tension Reinforcement Stress = $0.5f_y$
- 4.1. Nominal Control Point at Tension Reinforcement Stress = f_y
- 5.1. Nominal Control Point at Tension Reinforcement Stress = 0.005 in./in.
- 6.1. Nominal Control Point at Pure Bending
- 7.1. Maximum Nominal Axial Strength in Tension

Figure 2 – Irregular Section Interaction Diagram Control Points

Control Points (Moment Rotation about the Negative Y-Axis)

Begin the calculation for the moment capacity where the flange of the T-shaped cross-section is in compression and the column at the bottom of the stem is in tension.

1. Maximum Compression

1.1. Nominal axial compressive strength

From Tables 1 and 2:

Calculate total gross cross-sectional area:

$$A_g = b_1 \times h_1 + b_2 \times h_2 + b_3 \times h_3 = 140 \times 14 + 14 \times 360 + 24 \times 24 = 7,576 \text{ in.}^2$$

Calculate the center of gravity (geometrical centroid):

$$\bar{x} = \frac{b_1 \times h_1^2 / 2 + b_2 \times h_2 \times (h_1 + h_2 / 2) + b_3 \times h_3 \times (h_1 + h_2 + h_3 / 2)}{b_1 \times h_1 + b_2 \times h_2 + b_3 \times h_3}$$

$$\bar{x} = \frac{140 \times 14^2 / 2 + 14 \times 360 \times (14 + 360 / 2) + 24 \times 24 \times (14 + 360 + 24 / 2)}{140 \times 14 + 14 \times 360 + 24 \times 24} = 160.22 \text{ in.}$$

$$A_{st} = 12 \times 2 \times 0.79 + 2 \times 30 \times 0.31 + 8 \times 0.79 = 43.88 \text{ in.}^2$$

$$P_o = 0.85 f'_c (A_g - A_{st}) + f_y A_{st} \quad \text{ACI 318-14 (22.4.2.2)}$$

$$P_o = 0.85 \times 4000 \times (7,576 - 43.88) + 60000 \times 43.88 = 28,242 \text{ kips}$$

Since the section is irregular (not symmetrical) about the y-axis, the moment capacity associated with the maximum axial compressive strength is not equal to zero. As commonly is the case in symmetrical shapes with symmetrical reinforcing arrangements.

$$C_c = -0.85 \times f'_c \times A_g = -0.85 \times 4,000 \times 7,576 = -25,758 \text{ kip} \quad \text{ACI 318-14 (22.2.4.1)}$$

The area of the reinforcement has been included in the area (A_g) used to compute C_c . As a result, it is necessary to subtract $0.85 f'_c$ from f'_s before computing C_{si} for each reinforcement layer (i):

$$C_{si} = (f'_{si} - 0.85 f'_c) \times A_{si}$$

Where i indicates the reinforcement layer number as shown in the following Table.

The concrete compression force is located at the centroid of the section making the location of the geometric centroid coincide with the plastic centroid ($\bar{x} = \bar{x}_p$). Thus, the moment capacity is developed by the reinforcement only since the bars forces are not at the geometric centroid. The following Table shows the calculation of the moment capacity associated with the maximum axial compressive strength.

$$M_o = C_c \times (\bar{x} - \bar{x}_{unc}) + \sum_{i=1}^{35} C_{s,i} \times (\bar{x} - d_i) = -4,008 \text{ kip-ft}$$

Table 3 - Moment Capacity for the First Control Point

Layer	A _s /bar, in ²	# of bars	d, in	C _s , kip	M _{sc} , kip-ft
1	0.79	12	2.5	-536.6	-7,052.2
2	0.79	12	11.5	-536.6	-6,649.8
3	0.31	2	20.0	-35.1	-410.0
4	0.31	2	32.0	-35.1	-375.0
5	0.31	2	44.0	-35.1	-340.9
6	0.31	2	56.0	-35.1	-304.8
7	0.31	2	68.0	-35.1	-269.7
8	0.31	2	80.0	-35.1	-234.6
9	0.31	2	92.0	-35.1	-199.5
10	0.31	2	104.0	-35.1	-164.4
11	0.31	2	116.0	-35.1	-129.3
12	0.31	2	128.0	-35.1	-94.2
13	0.31	2	140.0	-35.1	-59.1
14	0.31	2	152.0	-35.1	-24.0
15	0.31	2	164.0	-35.1	11.1
16	0.31	2	176.0	-35.1	46.2
17	0.31	2	188.0	-35.1	81.2
18	0.31	2	200.0	-35.1	116.3
19	0.31	2	212.0	-35.1	151.4
20	0.31	2	224.0	-35.1	186.5
21	0.31	2	236.0	-35.1	221.6
22	0.31	2	248.0	-35.1	256.7
23	0.31	2	260.0	-35.1	291.8
24	0.31	2	272.0	-35.1	326.9
25	0.31	2	284.0	-35.1	362.0
26	0.31	2	296.0	-35.1	397.1
27	0.31	2	308.0	-35.1	432.2
28	0.31	2	320.0	-35.1	467.3
29	0.31	2	332.0	-35.1	502.3
30	0.31	2	344.0	-35.1	537.4
31	0.31	2	356.0	-35.1	572.5
32	0.31	2	368.0	-35.1	607.6
33	0.79	3	376.5	-134.1	2,417.7
34	0.79	2	386.0	-89.4	1,682.6
35	0.79	3	395.5	-134.1	2,630.1
M _o = ∑M _{sc} , kip-ft					-4,008

1.2. Factored axial compressive strength

$$\phi = 0.65$$

ACI 318-14 (Table 21.2.2)

$$\phi P_o = 0.65 \times 28,242 = 18,357.3 \text{ kips}$$

$$\phi M_o = \phi \times M_o = 0.65 \times -4,008 = -2,605.20 \text{ kip-ft}$$

1.3. Maximum (allowable) factored axial compressive strength

$$\phi P_{n,max} = 0.80 \times \phi P_o = 0.80 \times 18,357 = 14,685.8 \text{ kips}$$

ACI 318-14 (Table 22.4.2.1)

2. Bar Stress Near Tension Face Equal to Zero, ($\epsilon_s = f_s = 0$)

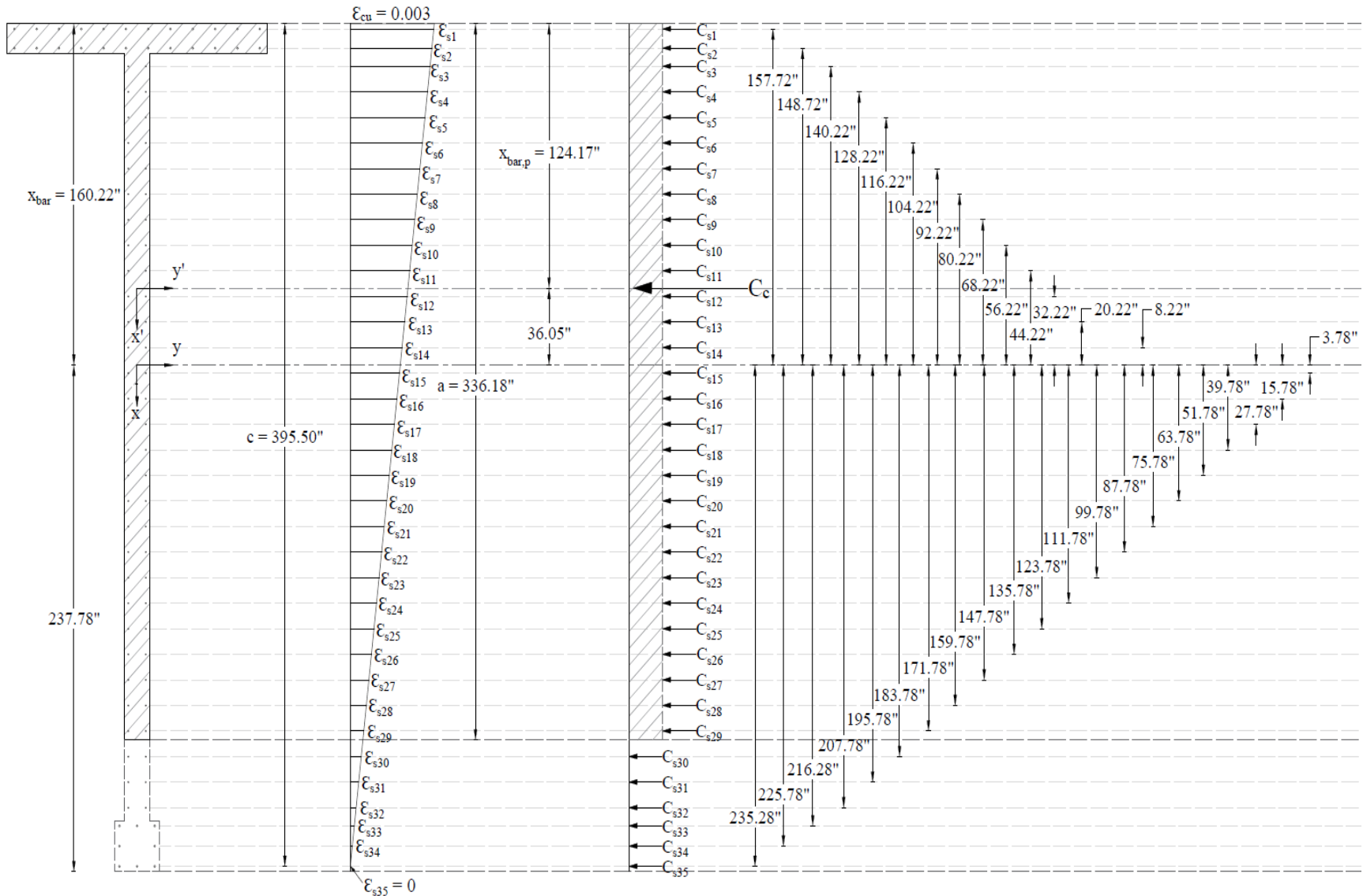

Figure 3 – Strains, Forces, and Moment Arms ($\epsilon_t = f_s = 0$)

Strain ϵ_s is zero in the extreme layer of tension steel. This case is considered when calculating an interaction diagram because it marks the change from compression lap splices being allowed on all longitudinal bars, to the more severe requirement of tensile lap splices. ACI 318-14 (10.7.5.2.1 and 2)

The following shows the general procedure to calculate the axial and moment capacities of the irregular wall section at this control point, all the calculated values are shown in the next Table.

2.1. c, a, and strains in the reinforcement

$$c = d_{35} = 395.5 \text{ in.}$$

Where c is the distance from the fiber of maximum compressive strain to the neutral axis.

ACI 318-14 (22.2.2.4.2)

$$a = \beta_1 \times c = 0.85 \times 395.5 = 336.2 \text{ in.}$$

ACI 318-14 (22.2.2.4.1)

Where:

a = Depth of equivalent rectangular stress block

$$\beta_1 = 0.85 - \frac{0.05 \times (f'_c - 4000)}{1000} = 0.85 - \frac{0.05 \times (4000 - 4000)}{1000} = 0.85$$

ACI 318-14 (Table 22.2.2.4.3)

$$\epsilon_{s,35} = 0$$

$$\therefore \phi = 0.65$$

ACI 318-14 (Table 21.2.2)

$$\epsilon_{cu} = 0.003$$

ACI 318-14 (22.2.2.1)

$$\epsilon_{s,i} = \epsilon_{cu} \left(\frac{d_i}{c} - 1 \right)$$

$$\epsilon_y = \frac{F_y}{E_s} = \frac{60}{29,000} = 0.00207$$

2.2. Forces in the concrete and steel

Since $a = 336.2 \text{ in.} > h_1 = 14 \text{ in.}$, the area and centroid of the concrete equivalent block (see the previous Figure) can be found as follows:

$$A_p = 14 \times 140 + (336 - 14) \times 14 = 6,470 \text{ in.}^2$$

$$\bar{x}_p = \frac{b_1 \times h_1^2 / 2 + b_2 \times (a - h_1) \times (h_1 + (a - h_1) / 2)}{b_1 \times h_1 + b_2 \times (a - h_1)}$$

$$\bar{x}_p = \frac{140 \times 14^2 / 2 + 14 \times (336 - 14) \times (14 + (336 - 14) / 2)}{140 \times 14 + 14 \times (336 - 14)} = 124.2 \text{ in.}$$

$$C_c = 0.85 \times f'_c \times A_p = 0.85 \times 4,000 \times 6,470 = 22,000 \text{ kip (compression)}$$

ACI 318-14 (22.2.2.4.1)

$$\text{if } \left\{ \begin{array}{l} \varepsilon_{s,i} \geq \varepsilon_y \rightarrow \text{reinforcement has yielded} \rightarrow f_{s,i} = f_y \\ \varepsilon_{s,i} < \varepsilon_y \rightarrow \text{reinforcement has not yielded} \rightarrow f_{s,i} = \varepsilon_{s,i} \times E_s \end{array} \right\}$$

If the reinforcement layer is located within the depth of the equivalent rectangular stress block (a), it is necessary to subtract $0.85f'_c$ from $f_{s,i}$ before computing $F_{s,i}$ since the area of the reinforcement in this layer has been included in the area used to compute C_c .

$$\text{if } \left\{ \begin{array}{l} d_i < a \rightarrow F_{s,i} = (f_{s,i} - 0.85f'_c) \times A_{s,i} \\ d_i > a \rightarrow F_{s,i} = f_{s,i} \times A_{s,i} \end{array} \right\}$$

The force developed in the reinforcement layer ($F_{s,i}$) is considered as compression force ($C_{s,i}$) if the effective depth of this steel layer (d_i) is less than c (the distance from the fiber of maximum compressive strain to the neutral axis), otherwise it is considered as tension force ($T_{s,i}$).

2.3. ϕP_n and ϕM_n

Using values from the next Table:

$$P_n = C_c + \sum_{i=1}^{35} C_{s,i} - \sum_{i=1}^{35} T_{s,i} = -23,786.2 \text{ kip}$$

$$\phi P_n = 0.65 \times -23,786 = -15,461.0 \text{ kip}$$

$$M_n = C_c \times (\bar{x} - \bar{x}_{unc}) + \sum_{i=1}^{35} C_{s,i} \times (\bar{x} - d_i) + \sum_{i=1}^{35} T_{s,i} \times (d_i - \bar{x}) = -80,364.54 \text{ kip-ft}$$

$$\phi M_n = 0.65 \times -80,365 = -52,236.95 \text{ kip-ft}$$

Table 4 - Axial and Moment Capacity for the Second Control Point

Layer	A _s /bar, in ²	# of bars	d, in	ε _s , in./in.	f _{s,i} , ksi	C _{s,i} , kip	T _{s,i} , kip	M _{n,i} , kip-ft
1	0.79	12	2.5	-0.00298	60.0	-536.6	0.0	-7052.2
2	0.79	12	11.5	-0.00291	60.0	-536.6	0.0	-6649.8
3	0.31	2	20.0	-0.00285	60.0	-35.1	0.0	-410.0
4	0.31	2	32.0	-0.00276	60.0	-35.1	0.0	-375.0
5	0.31	2	44.0	-0.00267	60.0	-35.1	0.0	-339.9
6	0.31	2	56.0	-0.00258	60.0	-35.1	0.0	-304.8
7	0.31	2	68.0	-0.00248	60.0	-35.1	0.0	-269.7
8	0.31	2	80.0	-0.00239	60.0	-35.1	0.0	-234.6
9	0.31	2	92.0	-0.0023	60.0	-35.1	0.0	-199.5
10	0.31	2	104.0	-0.00221	60.0	-35.1	0.0	-164.4
11	0.31	2	116.0	-0.00212	60.0	-35.1	0.0	-129.3
12	0.31	2	128.0	-0.00203	58.8	-34.4	0.0	-92.3
13	0.31	2	140.0	-0.00194	56.2	-32.7	0.0	-55.2
14	0.31	2	152.0	-0.00185	53.6	-31.1	0.0	-21.3
15	0.31	2	164.0	-0.00176	50.9	-29.5	0.0	9.3
16	0.31	2	176.0	-0.00166	48.3	-27.8	0.0	36.6
17	0.31	2	188.0	-0.00157	45.6	-26.2	0.0	60.6
18	0.31	2	200.0	-0.00148	43.0	-24.6	0.0	81.4
19	0.31	2	212.0	-0.00139	40.4	-22.9	0.0	98.9
20	0.31	2	224.0	-0.0013	37.7	-21.3	0.0	113.1
21	0.31	2	236.0	-0.00121	35.1	-19.6	0.0	124.1
22	0.31	2	248.0	-0.00112	32.4	-18.0	0.0	131.7
23	0.31	2	260.0	-0.00103	29.8	-16.4	0.0	136.1
24	0.31	2	272.0	-0.00094	27.2	-14.7	0.0	137.3
25	0.31	2	284.0	-0.00085	24.5	-13.1	0.0	135.1
26	0.31	2	296.0	-0.00075	21.9	-11.5	0.0	129.7
27	0.31	2	308.0	-0.00066	19.2	-9.8	0.0	121.0
28	0.31	2	320.0	-0.00057	16.6	-8.2	0.0	109.0
29	0.31	2	332.0	-0.00048	14.0	-6.6	0.0	93.8
30	0.31	2	344.0	-0.00039	11.3	-7.0	0.0	107.6
31	0.31	2	356.0	-0.0003	8.7	-5.4	0.0	87.9
32	0.31	2	368.0	-0.00021	6.0	-3.8	0.0	64.9
33	0.79	3	376.5	-0.00014	4.2	-9.9	0.0	178.5
34	0.79	2	386.0	-0.00007	2.1	-3.3	0.0	62.1
35	0.79	3	395.5	0.0	0.0	0.0	0.0	0.0
Concrete	---	$\bar{x}_p =$	124.2	---	---	-22,000	0.0	-66,085
					P _n , kip	-23,786	M _n , kip-ft	-80,365

3. Bar Stress Near Tension Face Equal to $0.5 f_y$, ($f_s = 0.5 f_y$)

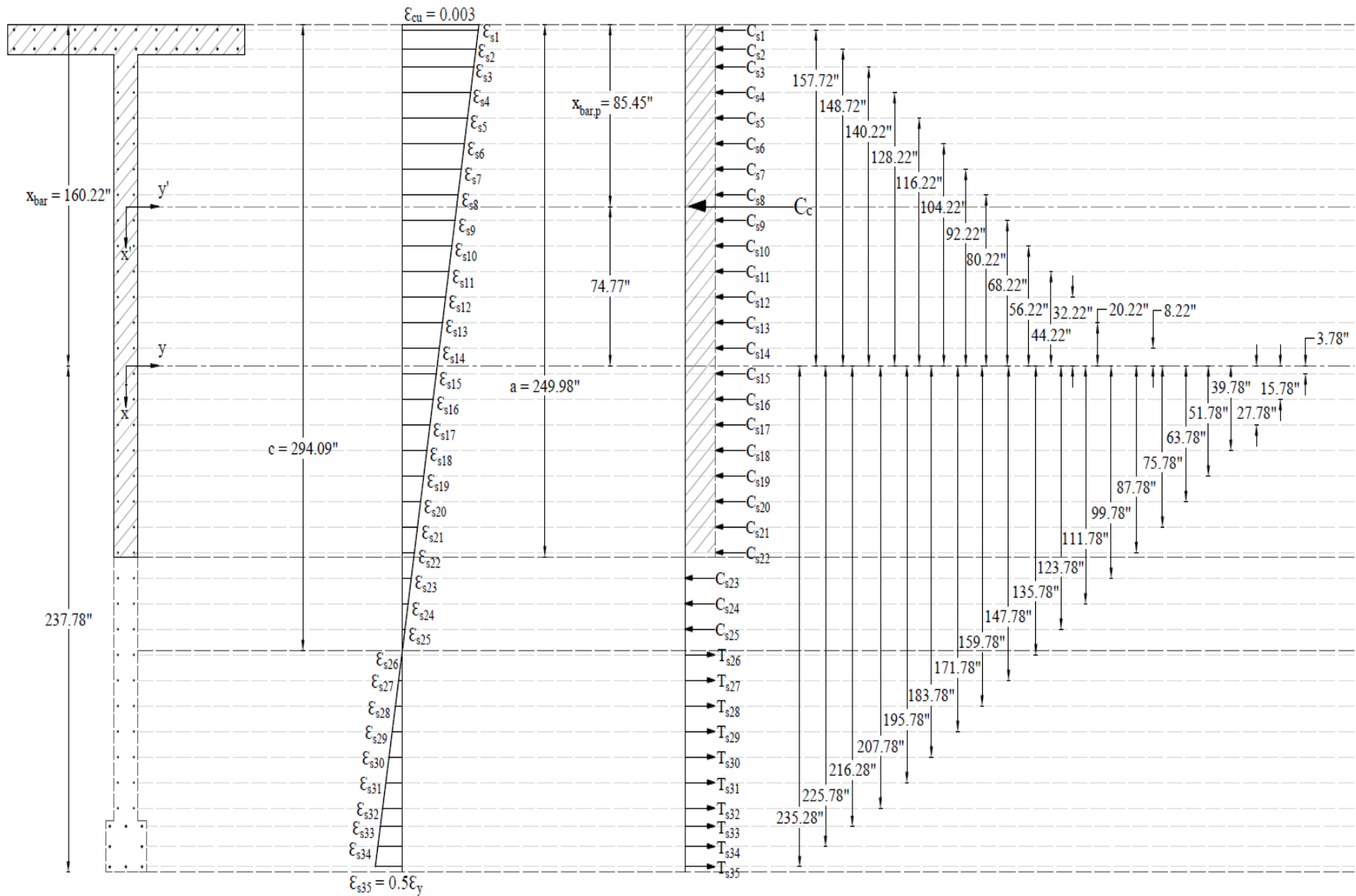

Figure 4 – Strains, Forces, and Moment Arms ($f_s = 0.5 f_y$)

The following show the general procedure to calculate the axial and moment capacities of the irregular wall section at this control point, all the calculated values are shown in the next Table.

3.1. c, a, and strains in the reinforcement

$$\varepsilon_y = \frac{f_y}{E_s} = \frac{60}{29,000} = 0.00207$$

$$\varepsilon_{s,35} = \frac{\varepsilon_y}{2} = \frac{0.00207}{2} = 0.00103 < \varepsilon_y \rightarrow \text{tension reinforcement has not yielded}$$

$$\therefore \phi = 0.65$$

ACI 318-14 (Table 21.2.2)

$$\varepsilon_{cu} = 0.003$$

ACI 318-14 (22.2.2.1)

$$c = \frac{d_{35}}{\varepsilon_{s,35} + \varepsilon_{cu}} \times \varepsilon_{cu} = \frac{395.5}{0.00103 + 0.003} \times 0.003 = 294.09 \text{ in.}$$

Where c is the distance from the fiber of maximum compressive strain to the neutral axis.

ACI 318-14 (22.2.2.4.2)

$$a = \beta_1 \times c = 0.85 \times 294.04 = 249.98 \text{ in.}$$

ACI 318-14 (22.2.2.4.1)

Where:

a = Depth of equivalent rectangular stress block

$$\beta_1 = 0.85 - \frac{0.05 \times (f'_c - 4000)}{1000} = 0.85 - \frac{0.05 \times (4000 - 4000)}{1000} = 0.85$$

ACI 318-14 (Table 22.2.2.4.3)

$$\varepsilon_{s,i} = \varepsilon_{cu} \left(\frac{d_i}{c} - 1 \right)$$

3.2. Forces in the concrete and steel

Since $a = 249.98 \text{ in.} > h_1 = 14 \text{ in.}$, the area and centroid of the concrete equivalent block (see the previous Figure) can be found as follows:

$$A_p = 14 \times 140 + (249.98 - 14) \times 14 = 5,264 \text{ in.}^2$$

$$\bar{x}_p = \frac{b_1 \times h_1^2 / 2 + b_2 \times (a - h_1) \times (h_1 + (a - h_1) / 2)}{b_1 \times h_1 + b_2 \times (a - h_1)}$$

$$\bar{x}_p = \frac{140 \times 14^2 / 2 + 14 \times (249.98 - 14) \times (14 + (249.98 - 14) / 2)}{140 \times 14 + 14 \times (249.98 - 14)} = 85.45 \text{ in.}$$

$$C_c = 0.85 \times f'_c \times A_p = 0.85 \times 4,000 \times 5,264 = 17,896 \text{ kip (compression)}$$

ACI 318-14 (22.2.2.4.1)

$$\text{if } \left\{ \begin{array}{l} \varepsilon_{s,i} \geq \varepsilon_y \rightarrow \text{reinforcement has yielded} \rightarrow f_{s,i} = f_y \\ \varepsilon_{s,i} < \varepsilon_y \rightarrow \text{reinforcement has not yielded} \rightarrow f_{s,i} = \varepsilon_{s,i} \times E_s \end{array} \right\}$$

If the reinforcement layer is located within the depth of the equivalent rectangular stress block (a), it is necessary to subtract $0.85f_c'$ from $f_{s,i}$ before computing $F_{s,i}$ since the area of the reinforcement in this layer has been included in the area used to compute C_c .

$$\text{if } \left\{ \begin{array}{l} d_i < a \rightarrow F_{s,i} = (f_{s,i} - 0.85f_c') \times A_{s,i} \\ d_i > a \rightarrow F_{s,i} = f_{s,i} \times A_{s,i} \end{array} \right\}$$

The force developed in the reinforcement layer ($F_{s,i}$) is considered as compression force ($C_{s,i}$) if the effective depth of this steel layer (d_i) is less than c (the distance from the fiber of maximum compressive strain to the neutral axis), otherwise it is considered as tension force ($T_{s,i}$).

3.3. ϕP_n and ϕM_n

Using values from the next Table:

$$P_n = C_c + \sum_{i=1}^{35} C_{s,i} - \sum_{i=1}^{35} T_{s,i} = -19,260.9 \text{ kip}$$

$$\phi P_n = 0.65 \times -19,261 = -12,519.6 \text{ kip}$$

$$M_n = C_c \times (\bar{x} - \bar{x}_{unc}) + \sum_{i=1}^{35} C_{s,i} \times (\bar{x} - d_i) + \sum_{i=1}^{35} T_{s,i} \times (d_i - \bar{x}) = -131,306.44 \text{ kip-ft}$$

$$\phi M_n = 0.65 \times -131,306 = -85,349.18 \text{ kip-ft}$$

Table 5 - Axial and Moment Capacity for the Third Control Point

Layer	A _s /bar, in ²	# of bars	d, in	ε _s , in./in.	f _{s,i} , ksi	C _{s,i} , kip	T _{s,i} , kip	M _{n,i} , kip-ft
1	0.79	12	2.5	-0.00297	60.0	-536.6	0.0	-7,052.2
2	0.79	12	11.5	-0.00288	60.0	-536.6	0.0	-6,649.8
3	0.31	2	20.0	-0.0028	60.0	-35.1	0.0	-410.0
4	0.31	2	32.0	-0.00267	60.0	-35.1	0.0	-375.0
5	0.31	2	44.0	-0.00255	60.0	-35.1	0.0	-339.9
6	0.31	2	56.0	-0.00243	60.0	-35.1	0.0	-304.8
7	0.31	2	68.0	-0.00231	60.0	-35.1	0.0	-269.7
8	0.31	2	80.0	-0.00218	60.0	-35.1	0.0	-234.6
9	0.31	2	92.0	-0.00206	59.8	-35.0	0.0	-198.7
10	0.31	2	104.0	-0.00194	56.2	-32.8	0.0	-153.5
11	0.31	2	116.0	-0.00182	52.7	-30.6	0.0	-112.6
12	0.31	2	128.0	-0.00169	49.1	-28.4	0.0	-76.1
13	0.31	2	140.0	-0.00157	45.6	-26.2	0.0	-44.1
14	0.31	2	152.0	-0.00145	42.0	-24.0	0.0	-16.4
15	0.31	2	164.0	-0.00133	38.5	-21.8	0.0	6.9
16	0.31	2	176.0	-0.0012	34.9	-19.6	0.0	25.7
17	0.31	2	188.0	-0.00108	31.4	-17.4	0.0	40.2
18	0.31	2	200.0	-0.00096	27.8	-15.1	0.0	50.2
19	0.31	2	212.0	-0.00084	24.3	-12.9	0.0	55.9
20	0.31	2	224.0	-0.00071	20.7	-10.7	0.0	57.1
21	0.31	2	236.0	-0.00059	17.2	-8.5	0.0	54.0
22	0.31	2	248.0	-0.00047	13.6	-6.3	0.0	46.4
23	0.31	2	260.0	-0.00035	10.1	-6.3	0.0	52.0
24	0.31	2	272.0	-0.00023	6.5	-4.1	0.0	37.7
25	0.31	2	284.0	-0.0001	3.0	-1.9	0.0	19.1
26	0.31	2	296.0	0.00002	0.6	0.0	0.4	-4.0
27	0.31	2	308.0	0.00014	4.1	0.0	2.6	-31.4
28	0.31	2	320.0	0.00026	7.7	0.0	4.8	-63.3
29	0.31	2	332.0	0.00039	11.2	0.0	7.0	-99.5
30	0.31	2	344.0	0.00051	14.8	0.0	9.2	-140.2
31	0.31	2	356.0	0.00063	18.3	0.0	11.4	-185.3
32	0.31	2	368.0	0.00075	21.9	0.0	13.6	-234.7
33	0.79	3	376.5	0.00084	24.4	0.0	57.8	-1,041.4
34	0.79	2	386.0	0.00094	27.2	0.0	43.0	-808.3
35	0.79	3	395.5	0.00103	30.0	0.0	71.1	-1,394.0
Concrete	---	$\bar{x}_p =$	85.45	---	---	-17,896	0.0	-111,512
					P _n , kip	-19,261	M _n , kip-ft	-131,306

4. Bar Stress Near Tension Face Equal to f_y , ($f_s = f_y$)

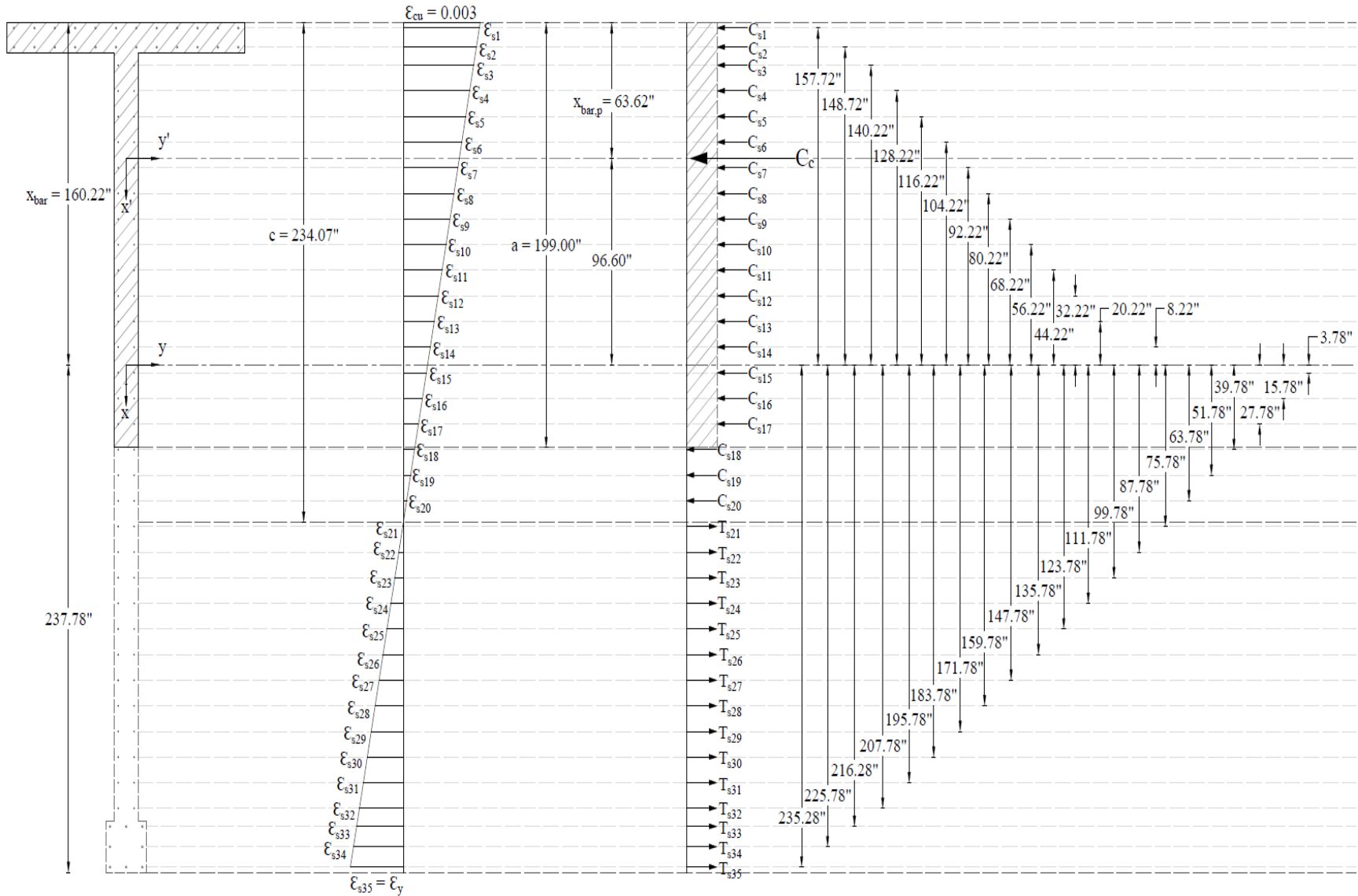

Figure 5 – Strains, Forces, and Moment Arms ($f_s = f_y$)

This strain distribution is called the balanced failure case and the compression-controlled strain limit. It marks the change from compression failures originating by crushing of the compression surface of the section, to tension failures initiated by yield of longitudinal reinforcement. It also marks the start of the transition zone for ϕ for columns and walls in which ϕ increases from 0.65 (or 0.75 for spiral columns) up to 0.90.

The following show the general procedure to calculate the axial and moment capacities of the irregular wall section at this control point, all the calculated values are shown in the next Table.

4.1. c, a, and strains in the reinforcement

$$\varepsilon_y = \frac{f_y}{E_s} = \frac{60}{29,000} = 0.00207$$

$$\varepsilon_{s,35} = \varepsilon_y = 0.00207 \rightarrow \text{tension reinforcement has yielded}$$

$$\therefore \phi = 0.65$$

ACI 318-14 (Table 21.2.2)

$$\varepsilon_{cu} = 0.003$$

ACI 318-14 (22.2.2.1)

$$c = \frac{d_{35}}{\varepsilon_{s,35} + \varepsilon_{cu}} \times \varepsilon_{cu} = \frac{395.5}{0.00207 + 0.003} \times 0.003 = 234.1 \text{ in.}$$

Where c is the distance from the fiber of maximum compressive strain to the neutral axis.

ACI 318-14 (22.2.2.4.2)

$$a = \beta_1 \times c = 0.85 \times 234.1 = 199 \text{ in.}$$

ACI 318-14 (22.2.2.4.1)

Where:

$$\beta_1 = 0.85 - \frac{0.05 \times (f'_c - 4000)}{1000} = 0.85 - \frac{0.05 \times (4000 - 4000)}{1000} = 0.85$$

ACI 318-14 (Table 22.2.2.4.3)

$$\varepsilon_{s,i} = \varepsilon_{cu} \left(\frac{d_i}{c} - 1 \right)$$

4.2. Forces in the concrete and steel

Since $a = 199 \text{ in.} > h_1 = 14 \text{ in.}$, the area and centroid of the concrete equivalent block (see the previous Figure) can be found as follows:

$$A_p = 14 \times 140 + (199 - 14) \times 14 = 4,550 \text{ in.}^2$$

$$\bar{x}_p = \frac{b_1 \times h_1^2 / 2 + b_2 \times (a - h_1) \times (h_1 + (a - h_1) / 2)}{b_1 \times h_1 + b_2 \times (a - h_1)}$$

$$\bar{x}_p = \frac{140 \times 14^2 / 2 + 14 \times (199 - 14) \times (14 + (199 - 14) / 2)}{140 \times 14 + 14 \times (199 - 14)} = 63.62 \text{ in.}$$

$$C_c = 0.85 \times f'_c \times A_p = 0.85 \times 4,000 \times 4,550 = 15,468 \text{ kip (compression)}$$

ACI 318-14 (22.2.2.4.1)

$$\text{if } \left\{ \begin{array}{l} \varepsilon_{s,i} \geq \varepsilon_y \rightarrow \text{reinforcement has yielded} \rightarrow f_{s,i} = f_y \\ \varepsilon_{s,i} < \varepsilon_y \rightarrow \text{reinforcement has not yielded} \rightarrow f_{s,i} = \varepsilon_{s,i} \times E_s \end{array} \right\}$$

If the reinforcement layer is located within the depth of the equivalent rectangular stress block (a), it is necessary to subtract $0.85f'_c$ from $f_{s,i}$ before computing $F_{s,i}$ since the area of the reinforcement in this layer has been included in the area used to compute C_c .

$$\text{if } \left\{ \begin{array}{l} d_i < a \rightarrow F_{s,i} = (f_{s,i} - 0.85f'_c) \times A_{s,i} \\ d_i > a \rightarrow F_{s,i} = f_{s,i} \times A_{s,i} \end{array} \right\}$$

The force developed in the reinforcement layer ($F_{s,i}$) is considered as compression force ($C_{s,i}$) if the effective depth of this steel layer (d_i) is less than c (the distance from the fiber of maximum compressive strain to the neutral axis), otherwise it is considered as tension force ($T_{s,i}$).

4.3. ϕP_n and ϕM_n

Using values from the next Table:

$$P_n = C_c + \sum_{i=1}^{35} C_{s,i} - \sum_{i=1}^{35} T_{s,i} = -16,396.8 \text{ kip}$$

$$\phi P_n = 0.65 \times -16,397 = -10,657.9 \text{ kip}$$

$$M_n = C_c \times (\bar{x} - \bar{x}_{unc}) + \sum_{i=1}^{35} C_{s,i} \times (\bar{x} - d_i) + \sum_{i=1}^{35} T_{s,i} \times (d_i - \bar{x}) = -149,883.78 \text{ kip-ft}$$

$$\phi M_n = 0.65 \times -149,884 = -97,424.46 \text{ kip-ft}$$

Table 6 - Axial and Moment Capacity for the Fourth Control Point

Layer	A _s /bar, in ²	# of bars	d, in	ε _s , in./in.	f _{s,i} , ksi	C _{s,i} , kip	T _{s,i} , kip	M _{n,i} , kip-ft
1	0.79	12	2.5	-0.00297	60.0	-536.6	0.0	-7052.2
2	0.79	12	11.5	-0.00285	60.0	-536.6	0.0	-6649.8
3	0.31	2	20.0	-0.00274	60.0	-35.1	0.0	-410.0
4	0.31	2	32.0	-0.00259	60.0	-35.1	0.0	-375.0
5	0.31	2	44.0	-0.00244	60.0	-35.1	0.0	-339.9
6	0.31	2	56.0	-0.00228	60.0	-35.1	0.0	-304.8
7	0.31	2	68.0	-0.00213	60.0	-35.1	0.0	-269.7
8	0.31	2	80.0	-0.00197	57.3	-33.4	0.0	-223.3
9	0.31	2	92.0	-0.00182	52.8	-30.6	0.0	-174.1
10	0.31	2	104.0	-0.00167	48.3	-27.9	0.0	-130.5
11	0.31	2	116.0	-0.00151	43.9	-25.1	0.0	-92.5
12	0.31	2	128.0	-0.00136	39.4	-22.3	0.0	-60.0
13	0.31	2	140.0	-0.00121	35.0	-19.6	0.0	-33.0
14	0.31	2	152.0	-0.00105	30.5	-16.8	0.0	-11.5
15	0.31	2	164.0	-0.0009	26.0	-14.0	0.0	4.4
16	0.31	2	176.0	-0.00074	21.6	-11.3	0.0	14.8
17	0.31	2	188.0	-0.00059	17.1	-8.5	0.0	19.7
18	0.31	2	200.0	-0.00044	12.7	-7.9	0.0	26.0
19	0.31	2	212.0	-0.00028	8.2	-5.1	0.0	21.9
20	0.31	2	224.0	-0.00013	3.7	-2.3	0.0	12.3
21	0.31	2	236.0	0.00002	0.7	0.0	0.4	-2.8
22	0.31	2	248.0	0.00018	5.2	0.0	3.2	-23.5
23	0.31	2	260.0	0.00033	9.6	0.0	6.0	-49.7
24	0.31	2	272.0	0.00049	14.1	0.0	8.7	-81.4
25	0.31	2	284.0	0.00064	18.6	0.0	11.5	-118.7
26	0.31	2	296.0	0.00079	23.0	0.0	14.3	-161.5
27	0.31	2	308.0	0.00095	27.5	0.0	17.0	-209.8
28	0.31	2	320.0	0.0011	31.9	0.0	19.8	-263.7
29	0.31	2	332.0	0.00126	36.4	0.0	22.6	-323.0
30	0.31	2	344.0	0.00141	40.9	0.0	25.3	-388.0
31	0.31	2	356.0	0.00156	45.3	0.0	28.1	-458.4
32	0.31	2	368.0	0.00172	49.8	0.0	30.9	-534.4
33	0.79	3	376.5	0.00183	52.9	0.0	125.5	-2261.3
34	0.79	2	386.0	0.00195	56.5	0.0	89.2	-1678.7
35	0.79	3	395.5	0.00207	60.0	0.0	142.2	-2788.1
Concrete	---	$\bar{x}_p =$	63.62	---	---	-15,468	0.0	-124,514
					P _n , kip	-16,397	M _n , kip-ft	-149,884

5. Bar Strain Near Tension Face Equal to 0.005 in./in., ($\epsilon_s = 0.005$ in./in.)

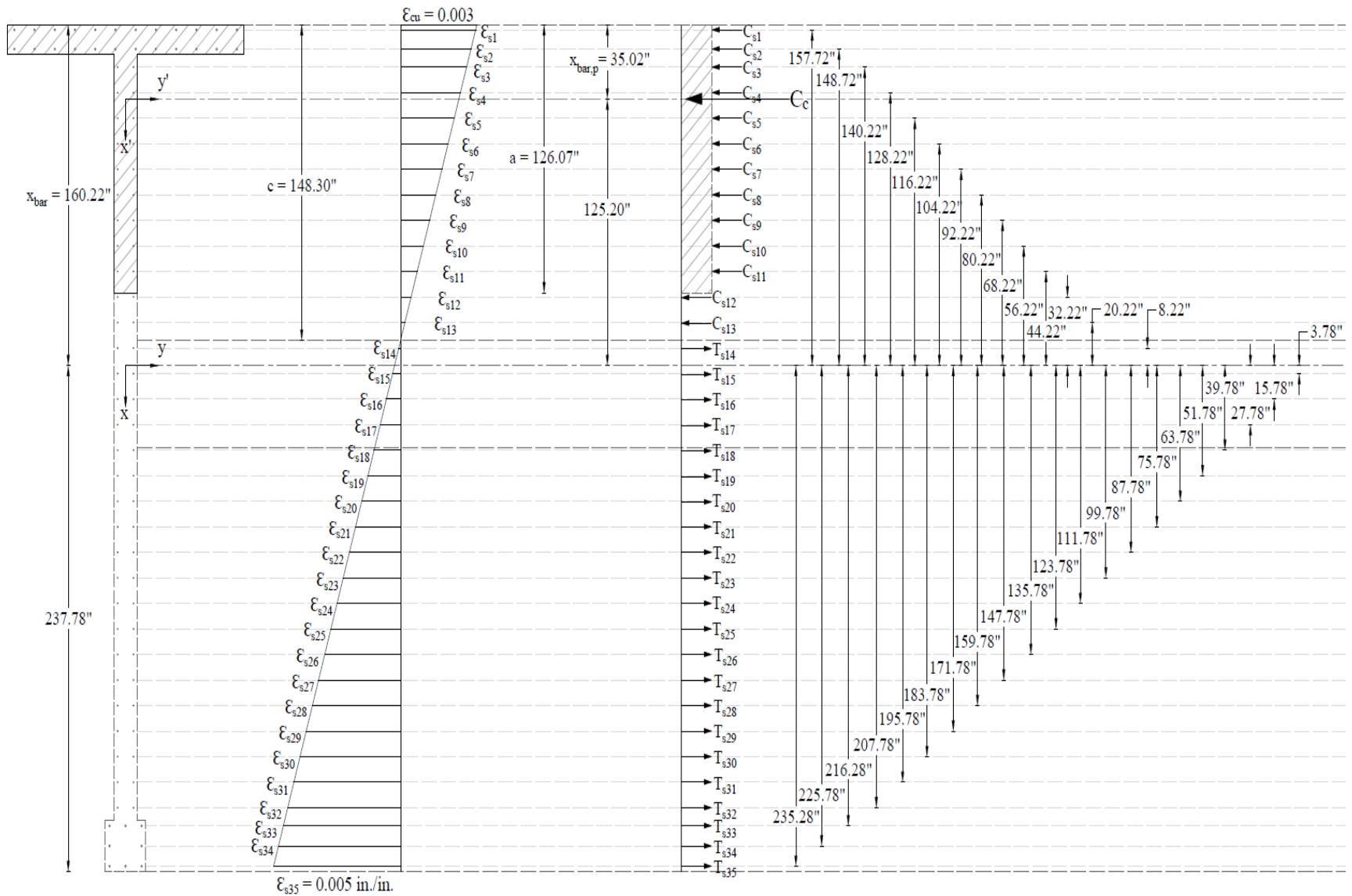

Figure 6 – Strains, Forces, and Moment Arms ($\epsilon_s = 0.005$ in./in.)

This corresponds to the tension-controlled strain limit of 0.005. It is the strain at the tensile limit of the transition zone for ϕ , used to define a tension-controlled section.

The following show the general procedure to calculate the axial and moment capacities of the irregular wall section at this control point, all the calculated values are shown in the next Table.

5.1. c, a, and strains in the reinforcement

$$\varepsilon_y = \frac{f_y}{E_s} = \frac{60}{29,000} = 0.00207$$

$$\varepsilon_{s,35} = 0.005 > \varepsilon_y \rightarrow \text{tension reinforcement has yielded}$$

$$\therefore \phi = 0.9$$

ACI 318-14 (Table 21.2.2)

$$\varepsilon_{cu} = 0.003$$

ACI 318-14 (22.2.2.1)

$$c = \frac{d_{35}}{\varepsilon_{s,35} + \varepsilon_{cu}} \times \varepsilon_{cu} = \frac{395.5}{0.005 + 0.003} \times 0.003 = 148.31 \text{ in.}$$

Where c is the distance from the fiber of maximum compressive strain to the neutral axis.

ACI 318-14 (22.2.2.4.2)

$$a = \beta_1 \times c = 0.85 \times 148.3 = 126.07 \text{ in.}$$

ACI 318-14 (22.2.2.4.1)

Where:

$$\beta_1 = 0.85 - \frac{0.05 \times (f'_c - 4000)}{1000} = 0.85 - \frac{0.05 \times (4000 - 4000)}{1000} = 0.85$$

ACI 318-14 (Table 22.2.2.4.3)

$$\varepsilon_{s,i} = \varepsilon_{cu} \left(\frac{d_i}{c} - 1 \right)$$

5.2. Forces in the concrete and steel

Since $a = 126.1 \text{ in.} > h_1 = 14 \text{ in.}$, the area and centroid of the concrete equivalent block (see the previous Figure) can be found as follows:

$$A_p = 14 \times 140 + (126.1 - 14) \times 14 = 3,529 \text{ in.}^2$$

$$\bar{x}_p = \frac{b_1 \times h_1^2 / 2 + b_2 \times (a - h_1) \times (h_1 + (a - h_1) / 2)}{b_1 \times h_1 + b_2 \times (a - h_1)}$$

$$\bar{x}_p = \frac{140 \times 14^2 / 2 + 14 \times (126.1 - 14) \times (14 + (126.1 - 14) / 2)}{140 \times 14 + 14 \times (126.1 - 14)} = 35.02 \text{ in.}$$

$$C_c = 0.85 \times f'_c \times A_p = 0.85 \times 4,000 \times 3,529 = 11,998 \text{ kip (compression)}$$

ACI 318-14 (22.2.2.4.1)

$$\text{if } \left\{ \begin{array}{l} \varepsilon_{s,i} \geq \varepsilon_y \rightarrow \text{reinforcement has yielded} \rightarrow f_{s,i} = f_y \\ \varepsilon_{s,i} < \varepsilon_y \rightarrow \text{reinforcement has not yielded} \rightarrow f_{s,i} = \varepsilon_{s,i} \times E_s \end{array} \right\}$$

If the reinforcement layer is located within the depth of the equivalent rectangular stress block (a), it is necessary to subtract $0.85f_c'$ from $f_{s,i}$ before computing $F_{s,i}$ since the area of the reinforcement in this layer has been included in the area used to compute C_c .

$$\text{if } \left\{ \begin{array}{l} d_i < a \rightarrow F_{s,i} = (f_{s,i} - 0.85f_c') \times A_{s,i} \\ d_i > a \rightarrow F_{s,i} = f_{s,i} \times A_{s,i} \end{array} \right\}$$

The force developed in the reinforcement layer ($F_{s,i}$) is considered as compression force ($C_{s,i}$) if the effective depth of this steel layer (d_i) is less than c (the distance from the fiber of maximum compressive strain to the neutral axis), otherwise it is considered as tension force ($T_{s,i}$).

5.3. ϕP_n and ϕM_n

Using values from the next Table:

$$P_n = C_c + \sum_{i=1}^{35} C_{s,i} - \sum_{i=1}^{35} T_{s,i} = -12,390.09 \text{ kip}$$

$$\phi P_n = 0.9 \times -12,390 = -11,151.08 \text{ kip}$$

$$M_n = C_c \times (\bar{x} - \bar{x}_{unc}) + \sum_{i=1}^{35} C_{s,i} \times (\bar{x} - d_i) + \sum_{i=1}^{35} T_{s,i} \times (d_i - \bar{x}) = -153,593.00 \text{ kip-ft}$$

$$\phi M_n = 0.9 \times -153,593 = -138,233.70 \text{ kip-ft}$$

Table 7 - Axial and Moment Capacity for the Fifth Control Point

Layer	A _s /bar, in ²	# of bars	d, in	ε _s , in./in.	f _{s,i} , ksi	C _{s,i} , kip	T _{s,i} , kip	M _{n,i} , kip-ft
1	0.79	12	2.5	-0.00295	60.0	-536.6	0.0	-7052.2
2	0.79	12	11.5	-0.00277	60.0	-536.6	0.0	-6649.8
3	0.31	2	20.0	-0.00260	60.0	-35.1	0.0	-410.0
4	0.31	2	32.0	-0.00235	60.0	-35.1	0.0	-375.0
5	0.31	2	44.0	-0.00211	60.0	-35.1	0.0	-339.9
6	0.31	2	56.0	-0.00187	54.2	-31.5	0.0	-273.3
7	0.31	2	68.0	-0.00162	47.1	-27.1	0.0	-208.3
8	0.31	2	80.0	-0.00138	40.1	-22.7	0.0	-152.0
9	0.31	2	92.0	-0.00114	33.0	-18.4	0.0	-104.5
10	0.31	2	104.0	-0.00090	26.0	-14.0	0.0	-65.6
11	0.31	2	116.0	-0.00065	19.0	-9.6	0.0	-35.5
12	0.31	2	128.0	-0.00041	11.9	-7.4	0.0	-19.8
13	0.31	2	140.0	-0.00017	4.9	-3.0	0.0	-5.1
14	0.31	2	152.0	0.00007	2.2	0.0	1.3	0.9
15	0.31	2	164.0	0.00032	9.2	0.0	5.7	-1.8
16	0.31	2	176.0	0.00056	16.2	0.0	10.0	-13.2
17	0.31	2	188.0	0.00080	23.3	0.0	14.4	-33.4
18	0.31	2	200.0	0.00105	30.3	0.0	18.8	-62.3
19	0.31	2	212.0	0.00129	37.4	0.0	23.2	-100.0
20	0.31	2	224.0	0.00153	44.4	0.0	27.5	-146.3
21	0.31	2	236.0	0.00177	51.4	0.0	31.9	-201.4
22	0.31	2	248.0	0.00202	58.5	0.0	36.3	-265.2
23	0.31	2	260.0	0.00226	60.0	0.0	37.2	-309.3
24	0.31	2	272.0	0.00250	60.0	0.0	37.2	-346.5
25	0.31	2	284.0	0.00274	60.0	0.0	37.2	-383.7
26	0.31	2	296.0	0.00299	60.0	0.0	37.2	-420.9
27	0.31	2	308.0	0.00323	60.0	0.0	37.2	-458.1
28	0.31	2	320.0	0.00347	60.0	0.0	37.2	-495.3
29	0.31	2	332.0	0.00372	60.0	0.0	37.2	-532.5
30	0.31	2	344.0	0.00396	60.0	0.0	37.2	-569.7
31	0.31	2	356.0	0.00420	60.0	0.0	37.2	-606.9
32	0.31	2	368.0	0.00444	60.0	0.0	37.2	-644.1
33	0.79	3	376.5	0.00462	60.0	0.0	142.2	-2562.9
34	0.79	2	386.0	0.00481	60.0	0.0	94.8	-1783.7
35	0.79	3	395.5	0.00500	60.0	0.0	142.2	-2788.1
Concrete	---	$\bar{x}_p =$	35.02	---	---	-11,998	0.0	-125,177
					P _n , kip	-12,390	M _n , kip-ft	-153,593

6. Pure Bending

This corresponds to the case where the nominal axial load capacity, P_n , is equal to zero. The following show the general iterative procedure to calculate the moment capacity of the irregular wall section at this control point, all the calculated values are shown in the next Table.

6.1. c, a, and strains in the reinforcement

Try $c = 4.322$ in.

Where c is the distance from the fiber of maximum compressive strain to the neutral axis.

ACI 318-14 (22.2.2.4.2)

$$a = \beta_1 \times c = 0.85 \times 4.322 = 3.674 \text{ in.}$$

ACI 318-14 (22.2.2.4.1)

Where:

$$\beta_1 = 0.85 - \frac{0.05 \times (f'_c - 4000)}{1000} = 0.85 - \frac{0.05 \times (4000 - 4000)}{1000} = 0.85 \quad \text{ACI 318-14 (Table 22.2.2.4.3)}$$

$$\varepsilon_{cu} = 0.003 \quad \text{ACI 318-14 (22.2.2.1)}$$

$$\varepsilon_y = \frac{f_y}{E_s} = \frac{60}{29,000} = 0.00207$$

$$\varepsilon_{s,35} = 0.003 \times \left(\frac{d_{35}}{c} - 1 \right) = 0.003 \times \left(\frac{395.5}{4.322} - 1 \right) = 0.27153 \text{ (Tension)} > \varepsilon_y \rightarrow \text{tension reinforcement has yielded}$$

$$\therefore \phi = 0.9 \quad \text{ACI 318-14 (Table 21.2.2)}$$

$$\varepsilon_{s,i} = \varepsilon_{cu} \left(\frac{d_i}{c} - 1 \right)$$

The maximum tensile strain calculated above is significantly higher than the yield strain and indicates the section is very lightly reinforced. Increasing the steel area will result in lower maximum strain and increase the moment capacity.

6.2. Forces in the concrete and steel

Since $a = 3.674$ in. $< h_1 = 14$ in., the area and centroid of the concrete equivalent block can be found as follows:

$$A_p = 3.674 \times 140 = 514 \text{ in.}^2$$

$$\bar{x}_p = \frac{a}{2} = \frac{3.674}{2} = 1.84 \text{ in.}$$

$$C_c = 0.85 \times f'_c \times A_{unc} = 0.85 \times 4,000 \times 514 = 1,749 \text{ kip (compression)}$$

ACI 318-14 (22.2.2.4.1)

$$\text{if } \left\{ \begin{array}{l} \varepsilon_{s,i} \geq \varepsilon_y \rightarrow \text{reinforcement has yielded} \rightarrow f_{s,i} = f_y \\ \varepsilon_{s,i} < \varepsilon_y \rightarrow \text{reinforcement has not yielded} \rightarrow f_{s,i} = \varepsilon_{s,i} \times E_s \end{array} \right\}$$

If the reinforcement layer is located within the depth of the equivalent rectangular stress block (a), it is necessary to subtract $0.85f'_c$ from $f_{s,i}$ before computing $F_{s,i}$ since the area of the reinforcement in this layer has been included in the area used to compute C_c .

The force developed in the reinforcement layer ($F_{s,i}$) is considered as compression force ($C_{s,i}$) if the effective depth of this steel layer (d_i) is less than c (the distance from the fiber of maximum compressive strain to the neutral axis), otherwise it is considered as tension force ($T_{s,i}$).

6.3. ϕP_n and ϕM_n

Using values from the next Table:

$$P_n = C_c + \sum_{i=1}^{35} C_{s,i} - \sum_{i=1}^{35} T_{s,i} \approx 0 \text{ kip}$$

The assumption that $c = 4.322$ in. is correct

$$M_n = C_c \times (\bar{x} - \bar{x}_{unc}) + \sum_{i=1}^{35} C_{s,i} \times (\bar{x} - d_i) + \sum_{i=1}^{35} T_{s,i} \times (d_i - \bar{x}) = -30,453.16 \text{ kip-ft}$$

$$\phi M_n = 0.9 \times -30,453 = -27,407.84 \text{ kip-ft}$$

Table 8 - Axial and Moment Capacity for the Sixth Control Point

Layer	A _s /bar, in ²	# of bars	d, in	ε _s , in./in.	f _{s,i} , ksi	C _{s,i} , kip	T _{s,i} , kip	M _{n,i} , kip-ft
1	0.79	12	2.5	-0.00126	36.7	-315.5	0.0	-4,146.1
2	0.79	12	11.5	0.00498	60.0	0.0	568.8	7,049.3
3	0.31	2	20.0	0.01088	60.0	0.0	37.2	434.7
4	0.31	2	32.0	0.01921	60.0	0.0	37.2	397.5
5	0.31	2	44.0	0.02754	60.0	0.0	37.2	360.3
6	0.31	2	56.0	0.03587	60.0	0.0	37.2	323.1
7	0.31	2	68.0	0.0442	60.0	0.0	37.2	285.9
8	0.31	2	80.0	0.05253	60.0	0.0	37.2	248.7
9	0.31	2	92.0	0.06086	60.0	0.0	37.2	211.5
10	0.31	2	104.0	0.06919	60.0	0.0	37.2	174.3
11	0.31	2	116.0	0.07752	60.0	0.0	37.2	137.1
12	0.31	2	128.0	0.08585	60.0	0.0	37.2	99.9
13	0.31	2	140.0	0.09418	60.0	0.0	37.2	62.7
14	0.31	2	152.0	0.10251	60.0	0.0	37.2	25.5
15	0.31	2	164.0	0.11084	60.0	0.0	37.2	-11.7
16	0.31	2	176.0	0.11917	60.0	0.0	37.2	-48.9
17	0.31	2	188.0	0.1275	60.0	0.0	37.2	-86.1
18	0.31	2	200.0	0.13582	60.0	0.0	37.2	-123.3
19	0.31	2	212.0	0.14415	60.0	0.0	37.2	-160.5
20	0.31	2	224.0	0.15248	60.0	0.0	37.2	-197.7
21	0.31	2	236.0	0.16081	60.0	0.0	37.2	-234.9
22	0.31	2	248.0	0.16914	60.0	0.0	37.2	-272.1
23	0.31	2	260.0	0.17747	60.0	0.0	37.2	-309.3
24	0.31	2	272.0	0.1858	60.0	0.0	37.2	-346.5
25	0.31	2	284.0	0.19413	60.0	0.0	37.2	-383.7
26	0.31	2	296.0	0.20246	60.0	0.0	37.2	-420.9
27	0.31	2	308.0	0.21079	60.0	0.0	37.2	-458.1
28	0.31	2	320.0	0.21912	60.0	0.0	37.2	-495.3
29	0.31	2	332.0	0.22745	60.0	0.0	37.2	-532.5
30	0.31	2	344.0	0.23578	60.0	0.0	37.2	-569.7
31	0.31	2	356.0	0.24411	60.0	0.0	37.2	-606.9
32	0.31	2	368.0	0.25244	60.0	0.0	37.2	-644.1
33	0.79	3	376.5	0.25834	60.0	0.0	142.2	-2,562.9
34	0.79	2	386.0	0.26493	60.0	0.0	94.8	-1,783.7
35	0.79	3	395.5	0.27153	60.0	0.0	142.2	-2,788.1
Concrete	---	$\bar{x}_p =$	1.84	---	---	-1,748.7	0.0	-23,079.9
					P _n , kip	0.0	M _n , kip-ft	-30,453

7. Maximum Tension

The final loading case to be considered is concentric axial tension. The strength under maximum axial tension is computed by assuming that the section is completely cracked through and subjected to a uniform strain greater than or equal to the yield strain in tension. The axial tensile strength under such a loading is equal to the yield strength of the reinforcement in tension.

7.1. P_{nt} and ϕP_{nt}

$$P_{nt} = f_y \times A_{st} = 60,000 \times 43.88 = 2,632.8 \text{ kip} \quad \text{ACI 318-14 (22.4.3.1)}$$

$$\phi = 0.9 \quad \text{ACI 318-14 (Table 21.2.2)}$$

$$\phi P_{nt} = 0.90 \times 2,633 = 2,369.5 \text{ kip}$$

7.2. M_n and ϕM_n

Since the section is irregular about the y-axis, the moment capacity associated with the maximum axial tensile strength is not equal to zero.

$$T_{s,i} = f \times A_{s,i}$$

Where i indicates the reinforcement layer number as shown in Table 10.

Using values from the next Table:

$$M_n = \sum_{i=1}^{35} T_{s,i} \times (d_i - \bar{x}) = 4,248.76 \text{ kip-ft}$$

$$\phi M_n = 0.9 \times 4,249 = 3,823.88 \text{ kip-ft}$$

As a summary, the following table shows the values for the control points necessary to create the interaction diagram for the irregular wall investigated in this example (when the moment is applied about the negative y-axis):

Control Point	ϕP_n , kip	ϕM_n , kip-ft	c, in	$\epsilon_{s,35}$, in.in.	ϕ
Maximum Compression	18,357.3	2,605.20	---	---	0.65
Allowable Compression	14,685.8	---	---	---	0.65
$f_s = 0.0$	15,461.0	52,236.95	395.50	0.00000	0.65
$f_s = 0.5f_y$	12,519.6	85,349.18	294.09	0.00103	0.65
Balanced Point	10,657.9	97,424.46	234.10	0.00207	0.65
Tension Control	11,151.1	138,233.70	148.31	0.00500	0.90
Pure Bending	0.0	27,407.84	4.32	0.27153	0.90
Maximum Tension	2,369.5	3,823.88	---	---	0.90

Table 10 - Axial and Moment Capacity for the Seventh Control Point

Layer	A_s/bar , in ²	# of bars	d, in	$f_{s,i}$, ksi	$T_{s,i}$, kip	$M_{n,i}$, kip-ft
1	0.79	12	2.5	60.0	568.8	7475.9
2	0.79	12	11.5	60.0	568.8	7049.3
3	0.31	2	20.0	60.0	37.2	434.7
4	0.31	2	32.0	60.0	37.2	397.5
5	0.31	2	44.0	60.0	37.2	360.3
6	0.31	2	56.0	60.0	37.2	323.1
7	0.31	2	68.0	60.0	37.2	285.9
8	0.31	2	80.0	60.0	37.2	248.7
9	0.31	2	92.0	60.0	37.2	211.5
10	0.31	2	104.0	60.0	37.2	174.3
11	0.31	2	116.0	60.0	37.2	137.1
12	0.31	2	128.0	60.0	37.2	99.9
13	0.31	2	140.0	60.0	37.2	62.7
14	0.31	2	152.0	60.0	37.2	25.5
15	0.31	2	164.0	60.0	37.2	-11.7
16	0.31	2	176.0	60.0	37.2	-48.9
17	0.31	2	188.0	60.0	37.2	-86.1
18	0.31	2	200.0	60.0	37.2	-123.3
19	0.31	2	212.0	60.0	37.2	-160.5
20	0.31	2	224.0	60.0	37.2	-197.7
21	0.31	2	236.0	60.0	37.2	-234.9
22	0.31	2	248.0	60.0	37.2	-272.1
23	0.31	2	260.0	60.0	37.2	-309.3
24	0.31	2	272.0	60.0	37.2	-346.5
25	0.31	2	284.0	60.0	37.2	-383.7
26	0.31	2	296.0	60.0	37.2	-420.9
27	0.31	2	308.0	60.0	37.2	-458.1
28	0.31	2	320.0	60.0	37.2	-495.3
29	0.31	2	332.0	60.0	37.2	-532.5
30	0.31	2	344.0	60.0	37.2	-569.7
31	0.31	2	356.0	60.0	37.2	-606.9
32	0.31	2	368.0	60.0	37.2	-644.1
33	0.79	3	376.5	60.0	142.2	-2562.9
34	0.79	2	386.0	60.0	94.8	-1783.7
35	0.79	3	395.5	60.0	142.2	-2788.1
Concrete	---	$\bar{x}_p =$	0.0	---	0.0	0.0
					P_n , kip	2,633
					M_n , kip-ft	4,249

Control Points (Moment Rotation about the Positive Y-Axis)

Since the wall section is not symmetrical (irregular) about the y-axis, the rotation of moment about the negative or positive y-axis results in different values for the control points (except for the maximum compression and maximum tension control points, these two points are the same for both cases). The following table shows the control points (when the moment is applied about the positive y-axis) obtained using the same procedure described above for the case when the moment is applied about the negative y-axis. The following two figures show the differences in the strain and force distribution for both cases for the same control point.

Table 11 - Control Points (Moment Applied about the Positive Y-Axis)					
Control Point	ϕP_n , kip	ϕM_n , kip-ft	c, in	$\epsilon_{s,35}$, in.in.	ϕ
Maximum Compression	18,357.3	2,605.17	---	---	0.65
Allowable Compression	14,685.8	---	---	---	0.65
$f_s = 0.0$	11,614.1	77,723.02	395.50	0.00000	0.65
$f_s = 0.5f_y$	8,417.7	95,118.94	294.09	0.00103	0.65
Balanced Point	6,299.7	98,452.51	234.07	0.00207	0.65
Tension Control	5,105.4	116,488.52	148.31	0.00500	0.90
Pure Bending	0.0	48,401.33	28.26	0.03898	0.90
Maximum Tension	2,369.5	3,823.88	---	---	0.90

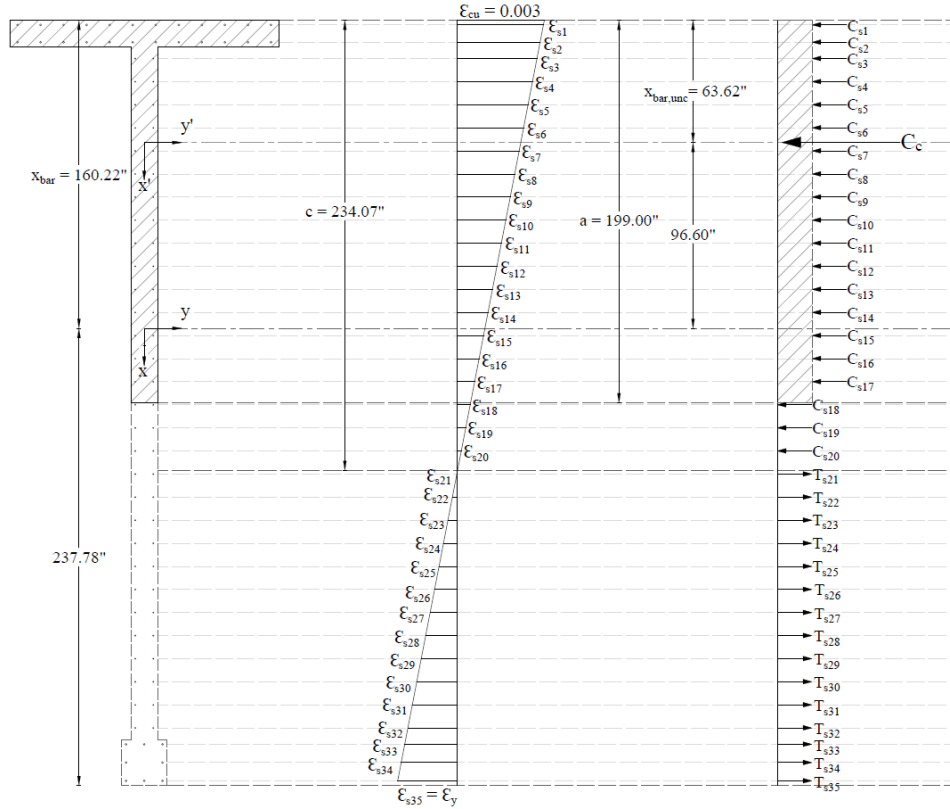

Figure 7 – Strains and Forces Distribution ($f_s = f_y$) (Moment about Negative Y-Axis)

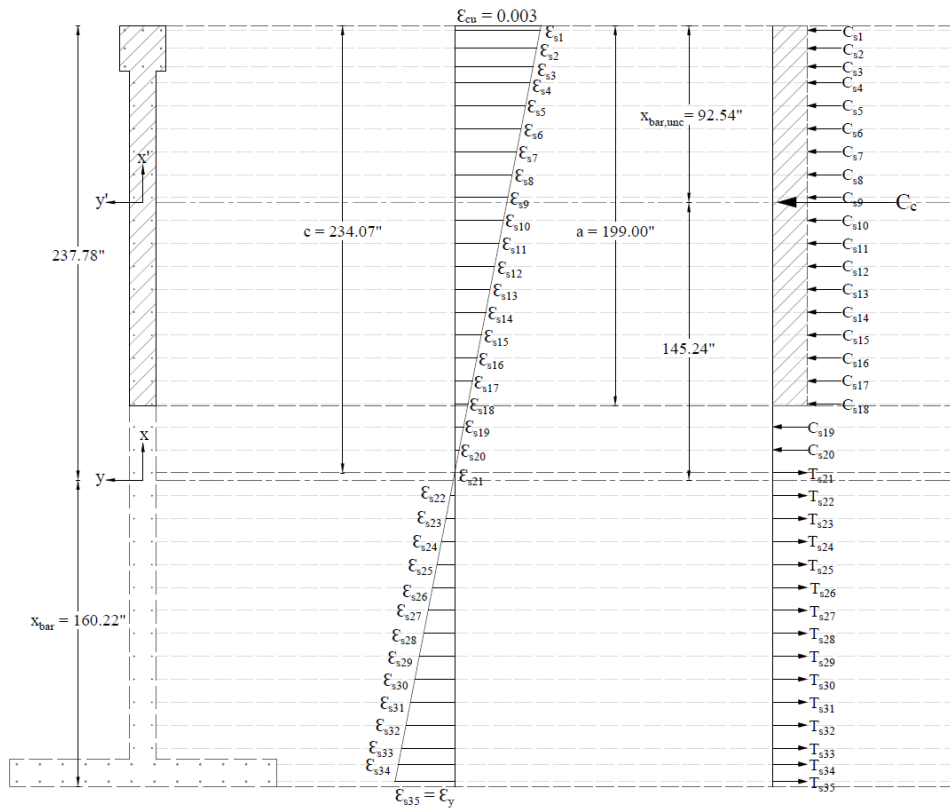

Figure 8 – Strains and Forces Distribution ($f_s = f_y$) (Moment about Positive Y-Axis)

8. Column Interaction Diagram - spColumn Software

spColumn program performs the analysis of the reinforced concrete section conforming to the provisions of the Strength Design Method and Unified Design Provisions with all conditions of strength satisfying the applicable conditions of equilibrium and strain compatibility. For this wall section, investigation mode was used with control points using the 318-14.

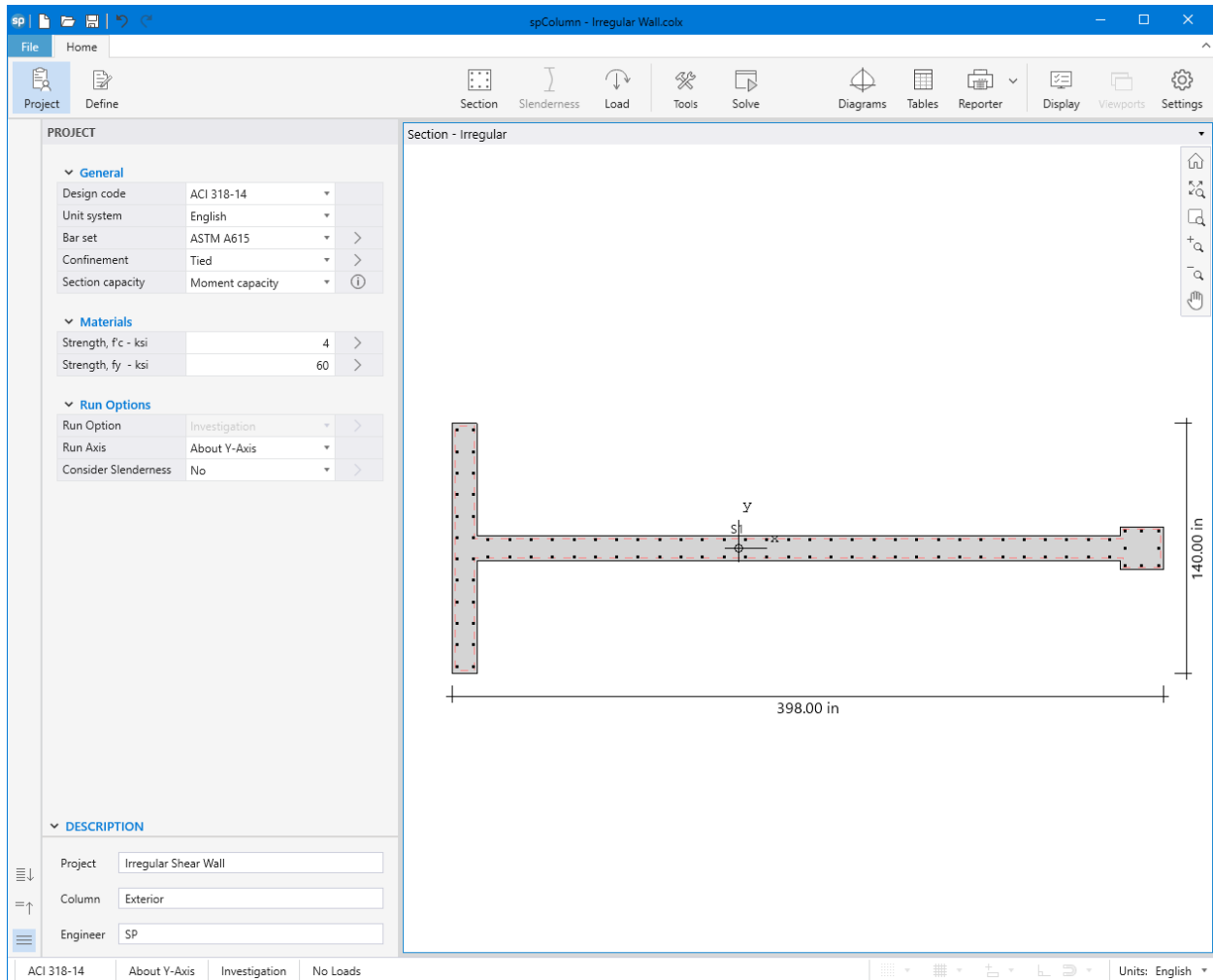

Figure 9 –spColumn Interface

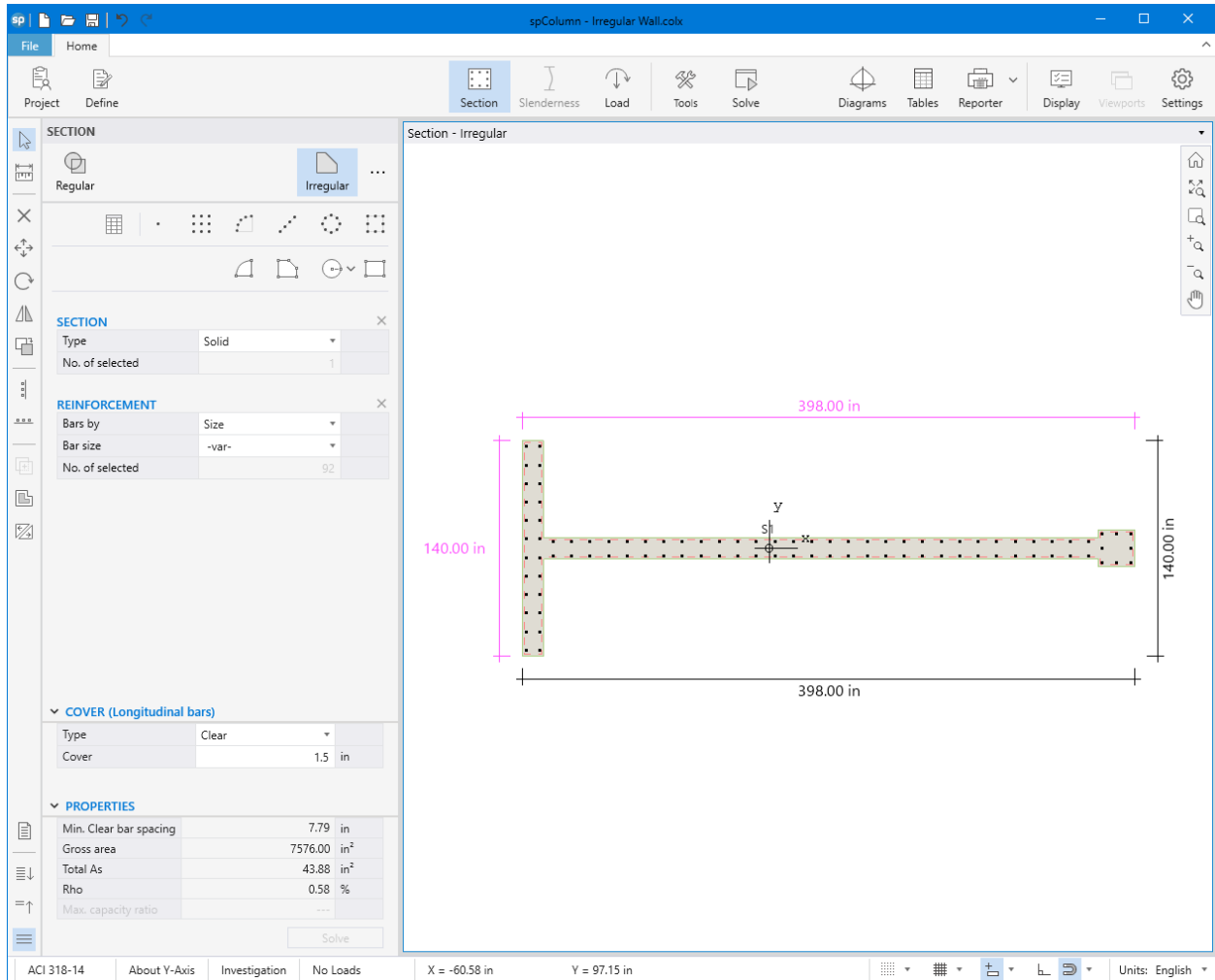

Figure 10 – spColumn Model Editor

Alternatively, the section and reinforcement arrangement can be imported to [spColumn](#) as an AutoCad file (.dxf). The following figures show the section being imported to [spColumn](#) directly from AutoCad 2021.

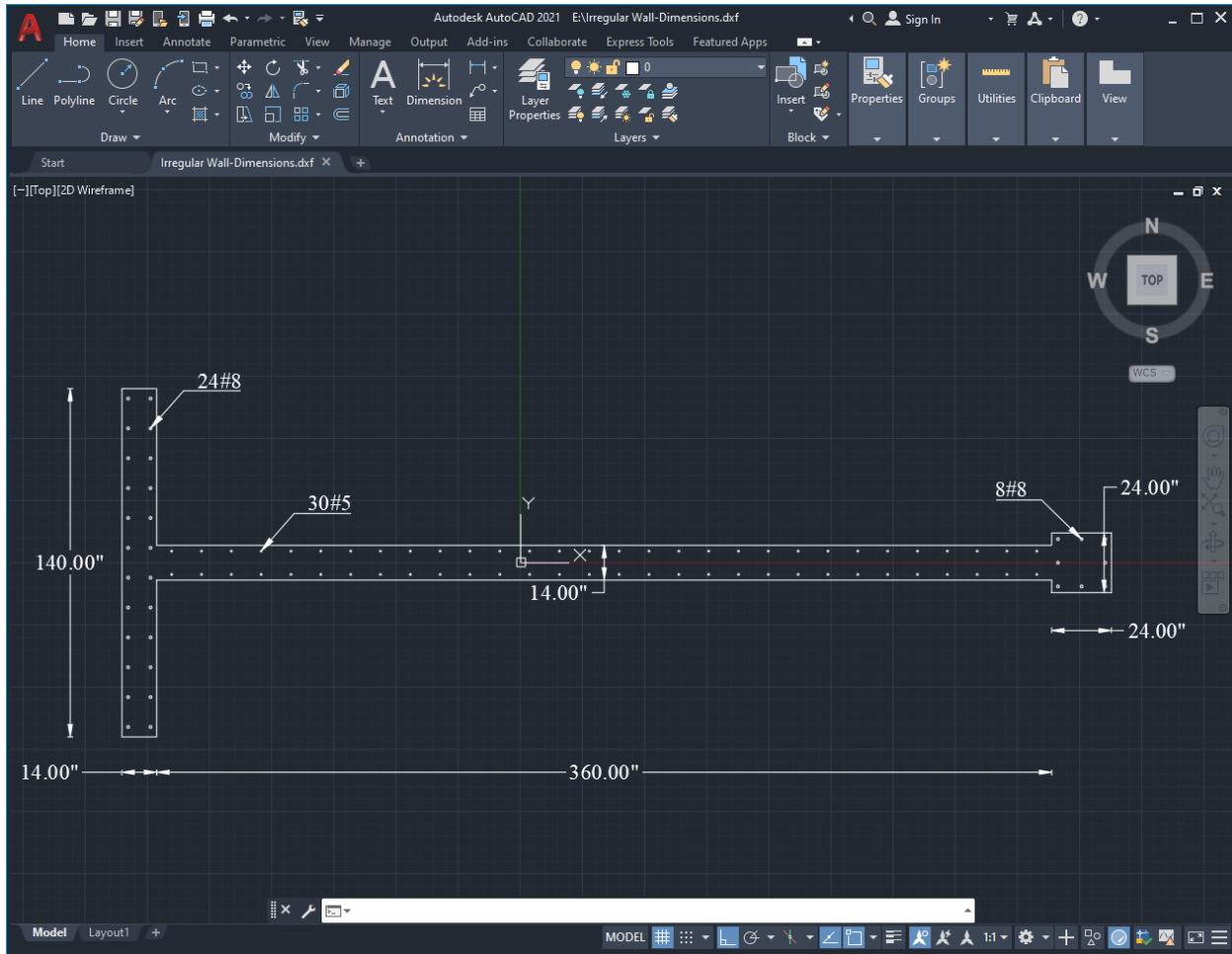

Figure 11 – Wall Section Using AutoCad (.dxf file)

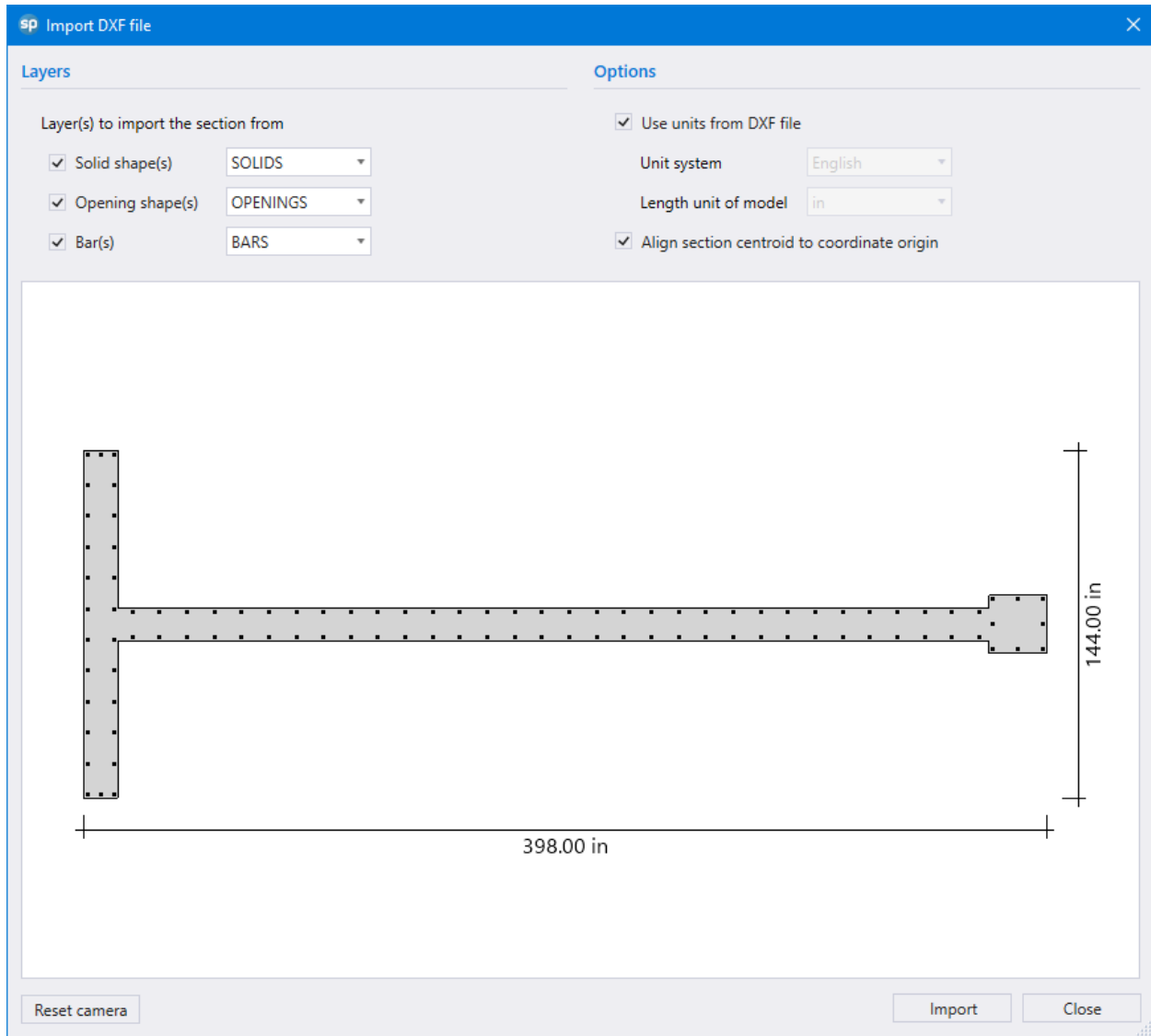

Figure 12 – Importing Wall Section from DXF file to [spColumn](#)

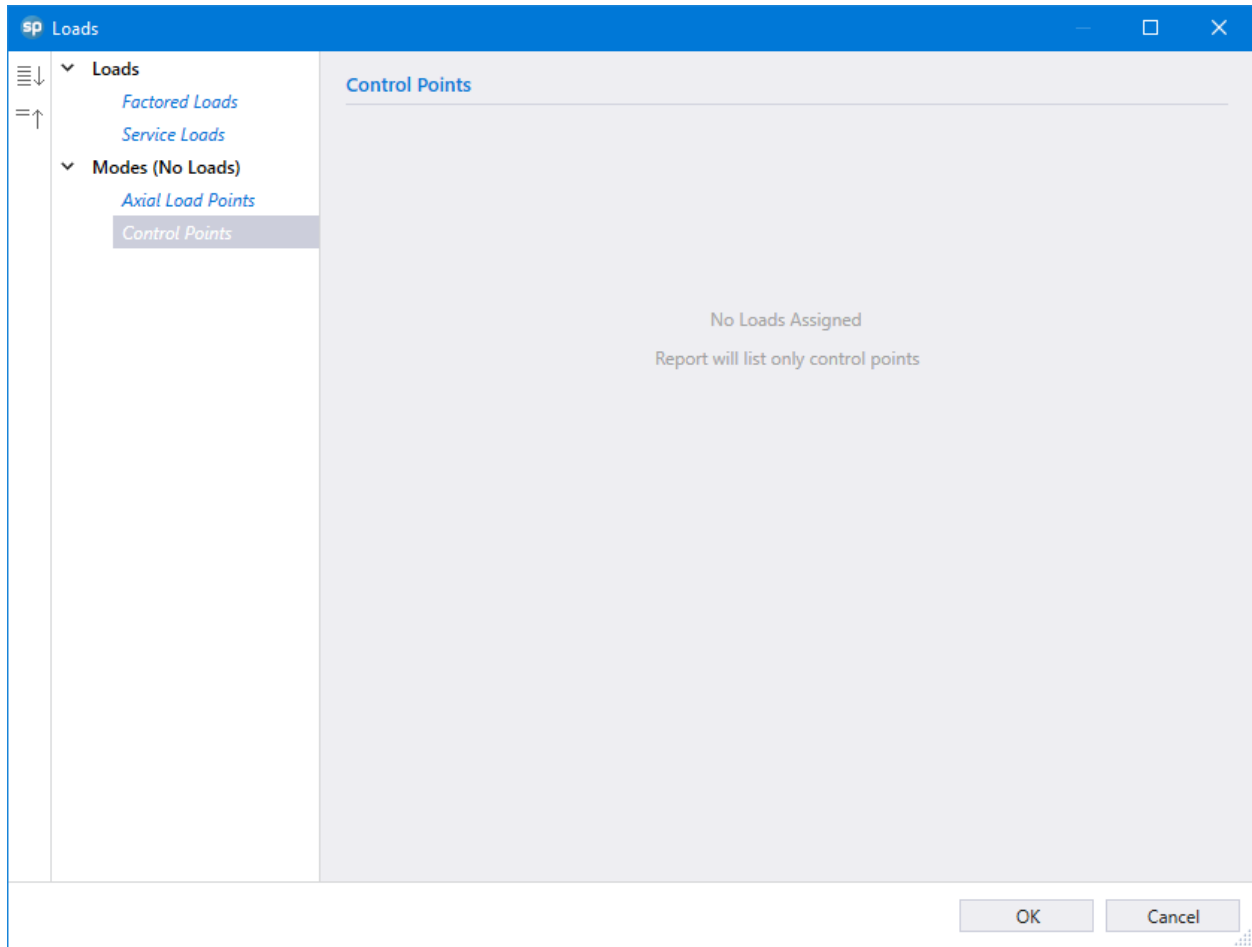

Figure 13 – Defining Loads / Modes (spColumn)

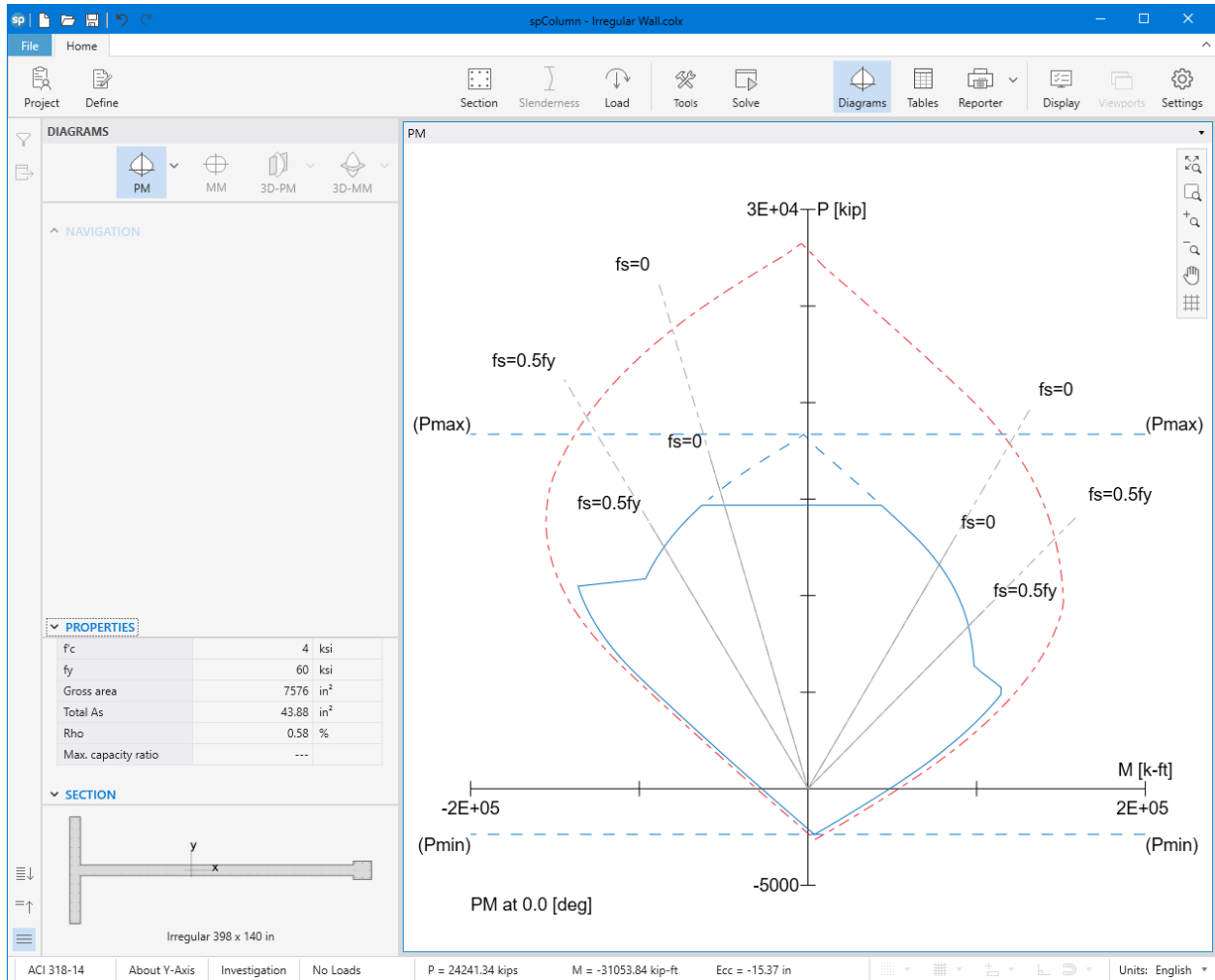
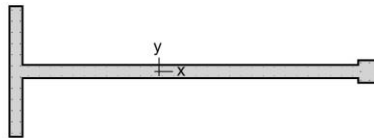

Figure 14 – Shear Wall P-M Interaction Diagram about the Y-Axis (spColumn)



spColumn v10.00 (TM)
Computer program for the Strength Design of Reinforced Concrete Sections
Copyright - 1988-2021, STRUCTUREPOINT, LLC.
All rights reserved



StructurePoint

Licensee stated below acknowledges that STRUCTUREPOINT (SP) is not and cannot be responsible for either the accuracy or adequacy of the material supplied as input for processing by the spColumn computer program. Furthermore, STRUCTUREPOINT neither makes any warranty expressed nor implied with respect to the correctness of the output prepared by the spColumn program. Although STRUCTUREPOINT has endeavored to produce spColumn error free the program is not and cannot be certified infallible. The final and only responsibility for analysis, design and engineering documents is the licensee's. Accordingly, STRUCTUREPOINT disclaims all responsibility in contract, negligence or other tort for any analysis, design or engineering documents prepared in connection with the use of the spColumn program. Licensed to: StructurePoint, LLC. License ID: 00000-0000000-4-20FC1-20FC1

Contents

1. General Information	3
2. Material Properties	3
2.1. Concrete	3
2.2. Steel	3
3. Section	3
3.1. Shape and Properties	3
3.2. Section Figure	4
3.3. Solids	4
3.3.1. S1	4
4. Reinforcement	4
4.1. Bar Set: ASTM A615	4
4.2. Confinement and Factors	4
4.3. Arrangement	4
4.4. Bars Provided	5
5. Control Points	5
6. Diagrams	7
6.1. PM at $\theta=0$ [deg]	7

List of Figures

Figure 1: Column section	4
--------------------------------	---

STRUCTUREPOINT - spColumn v10.00 (TM)
Licensed to: StructurePoint, LLC. License ID: 00000-0000000-4-20FC1-20FC1
E:\StructurePoint\spColumn\Irregular Wall.colx

Page | 3
5/25/2022
11:41 AM

1. General Information

File Name	E:\StructurePoint\spColumn\Irregular Wall.colx
Project	Irregular Shear Wall
Column	Exterior
Engineer	SP
Code	ACI 318-14
Bar Set	ASTM A615
Units	English
Run Option	Investigation
Run Axis	Y - axis
Slenderness	Not Considered
Column Type	Structural
Capacity Method	Moment capacity

2. Material Properties

2.1. Concrete

Type	Standard
f'_c	4 ksi
E_c	3605 ksi
f_c	3.4 ksi
ϵ_u	0.003 in/in
β_1	0.85

2.2. Steel

Type	Standard
f_y	60 ksi
E_s	29000 ksi
ϵ_{sy}	0.00206897 in/in

3. Section

3.1. Shape and Properties

Type	Irregular
A_g	7576 in ²
I_x	3.3113e+006 in ⁴
I_y	1.35619e+008 in ⁴
r_x	20.9064 in
r_y	133.795 in
X_o	-0.000420737 in
Y_o	0 in

3.2. Section Figure

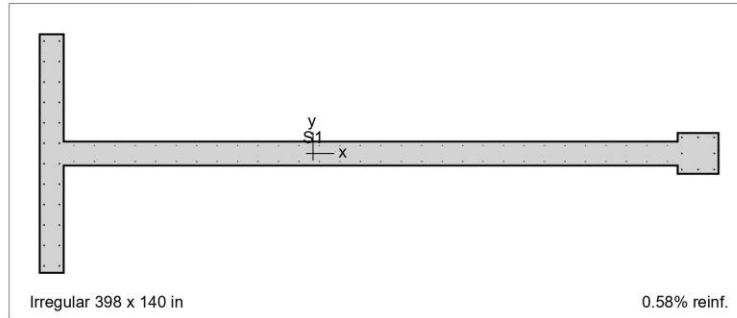

Figure 1: Column section

3.3. Solids

3.3.1. S1

Points	X in	Y in	Points	X in	Y in	Points	X in	Y in
1	-146.2	7.0	2	213.8	7.0	3	213.8	12.0
4	237.8	12.0	5	237.8	-12.0	6	213.8	-12.0
7	213.8	-7.0	8	-146.2	-7.0	9	-146.2	-70.0
10	-160.2	-70.0	11	-160.2	70.0	12	-146.2	70.0

4. Reinforcement

4.1. Bar Set: ASTM A615

Bar	Diameter in	Area in ²	Bar	Diameter in	Area in ²	Bar	Diameter in	Area in ²
#3	0.38	0.11	#4	0.50	0.20	#5	0.63	0.31
#6	0.75	0.44	#7	0.88	0.60	#8	1.00	0.79
#9	1.13	1.00	#10	1.27	1.27	#11	1.41	1.56
#14	1.69	2.25	#18	2.26	4.00			

4.2. Confinement and Factors

Confinement type	Tied
For #10 bars or less	#3 ties
For larger bars	#4 ties
Capacity Reduction Factors	
Axial compression, (a)	0.8
Tension controlled ϕ , (b)	0.9
Compression controlled ϕ , (c)	0.65

4.3. Arrangement

Pattern	Irregular
Bar layout	---
Cover to	---
Clear cover	---
Bars	---

STRUCTUREPOINT - spColumn v10.00 (TM)
Licensed to: StructurePoint, LLC. License ID: 00000-0000000-4-20FC1-20FC1
E:\StructurePoint\spColumn\Irregular Wall.colx

Page | 5
5/25/2022
11:41 AM

Total steel area, A_s	43.88 in ²
Rho	0.58 %
Minimum clear spacing	7.79 in

(Note: Rho < 1.0%)

4.4. Bars Provided

Area in ²	X in	Y in	Area in ²	X in	Y in	Area in ²	X in	Y in
0.79	235.3	9.5	0.79	235.3	-9.5	0.79	216.3	9.5
0.79	216.3	-9.5	0.79	225.8	9.5	0.79	225.8	-9.5
0.79	216.3	0.0	0.79	235.3	0.0	0.31	-140.2	4.7
0.31	-140.2	-4.7	0.31	-128.2	4.7	0.31	-128.2	-4.7
0.31	-116.2	4.7	0.31	-116.2	-4.7	0.31	-104.2	4.7
0.31	-104.2	-4.7	0.31	-92.2	4.7	0.31	-92.2	-4.7
0.31	-80.2	4.7	0.31	-80.2	-4.7	0.31	-68.2	4.7
0.31	-68.2	-4.7	0.31	-56.2	4.7	0.31	-56.2	-4.7
0.31	-44.2	4.7	0.31	-44.2	-4.7	0.31	-32.2	4.7
0.31	-32.2	-4.7	0.31	-20.2	4.7	0.31	-20.2	-4.7
0.31	-8.2	4.7	0.31	-8.2	-4.7	0.31	3.8	4.7
0.31	3.8	-4.7	0.31	15.8	4.7	0.31	15.8	-4.7
0.31	27.8	4.7	0.31	27.8	-4.7	0.31	39.8	4.7
0.31	39.8	-4.7	0.31	51.8	4.7	0.31	51.8	-4.7
0.31	63.8	4.7	0.31	63.8	-4.7	0.31	75.8	4.7
0.31	75.8	-4.7	0.31	87.8	4.7	0.31	87.8	-4.7
0.31	99.8	4.7	0.31	99.8	-4.7	0.31	111.8	4.7
0.31	111.8	-4.7	0.31	123.8	4.7	0.31	123.8	-4.7
0.31	135.8	4.7	0.31	135.8	-4.7	0.31	147.8	4.7
0.31	147.8	-4.7	0.31	159.8	4.7	0.31	159.8	-4.7
0.31	171.8	4.7	0.31	171.8	-4.7	0.31	183.8	4.7
0.31	183.8	-4.7	0.31	195.8	4.7	0.31	195.8	-4.7
0.31	207.8	4.7	0.31	207.8	-4.7	0.79	-157.7	-66.0
0.79	-157.7	-54.0	0.79	-157.7	-42.0	0.79	-157.7	-30.0
0.79	-157.7	-18.0	0.79	-157.7	-6.0	0.79	-157.7	6.0
0.79	-157.7	18.0	0.79	-157.7	30.0	0.79	-157.7	42.0
0.79	-157.7	54.0	0.79	-157.7	66.0	0.79	-148.7	-66.0
0.79	-148.7	-54.0	0.79	-148.7	-42.0	0.79	-148.7	-30.0
0.79	-148.7	-18.0	0.79	-148.7	-6.0	0.79	-148.7	6.0
0.79	-148.7	18.0	0.79	-148.7	30.0	0.79	-148.7	42.0
0.79	-148.7	54.0	0.79	-148.7	66.0			

5. Control Points

About Point	P kip	X-Moment k-ft	Y-Moment k-ft	NA Depth in	d _i Depth in	ϵ_t	ϕ
Y @ Max compression	18357.3	0.00	-2605.17	1274.38	395.50	-0.00207	0.65000
Y @ Allowable comp.	14685.8	0.00	43453.01	457.13	395.50	-0.00040	0.65000
Y @ $f_s = 0.0$	11614.1	0.00	77723.02	395.50	395.50	0.00000	0.65000
Y @ $f_s = 0.5 f_y$	8417.7	0.00	95118.94	294.09	395.50	0.00103	0.65000
Y @ Balanced point	6299.7	0.00	98452.51	234.07	395.50	0.00207	0.65000
Y @ Tension control	5105.4	0.00	116488.59	148.31	395.50	0.00500	0.90000
Y @ Pure bending	0.0	0.00	48401.51	28.26	395.50	0.03898	0.90000
Y @ Max tension	-2369.5	0.00	3823.87	0.00	395.50	9.99999	0.90000
-Y @ Max compression	18357.3	0.00	-2605.14	1274.37	395.50	-0.00207	0.65000
-Y @ $f_s = 0.0$	15461.0	0.00	-52237.39	395.50	395.50	0.00000	0.65000
-Y @ Allowable comp.	14685.8	0.00	-62826.55	368.21	395.50	0.00022	0.65000

STRUCTUREPOINT - spColumn v10.00 (TM)
Licensed to: StructurePoint, LLC. License ID: 00000-0000000-4-20FC1-20FC1
E:\StructurePoint\spColumn\Irregular Wall.colx

Page | 6
5/25/2022
11:41 AM

About Point	P kip	X-Moment k-ft	Y-Moment k-ft	NA Depth in	d _t Depth in	ε _t	φ
-Y @ f _s = 0.5 f _y	12519.6	0.00	-85349.34	294.09	395.50	0.00103	0.65000
-Y @ Balanced point	10657.9	0.00	-97424.52	234.07	395.50	0.00207	0.65000
-Y @ Tension control	11151.1	0.00	-138233.59	148.31	395.50	0.00500	0.90000 *
-Y @ Pure bending	0.0	-0.01	-27406.32	4.32	395.50	0.27154	0.90000
-Y @ Max tension	-2369.5	0.00	3823.87	0.00	395.50	9.99999	0.90000

* Axial load capacity increase in transition zone between Balanced Point and Tension Control is not represented graphically and is not considered in section design and investigation.

6. Diagrams

6.1. PM at $\theta=0$ [deg]

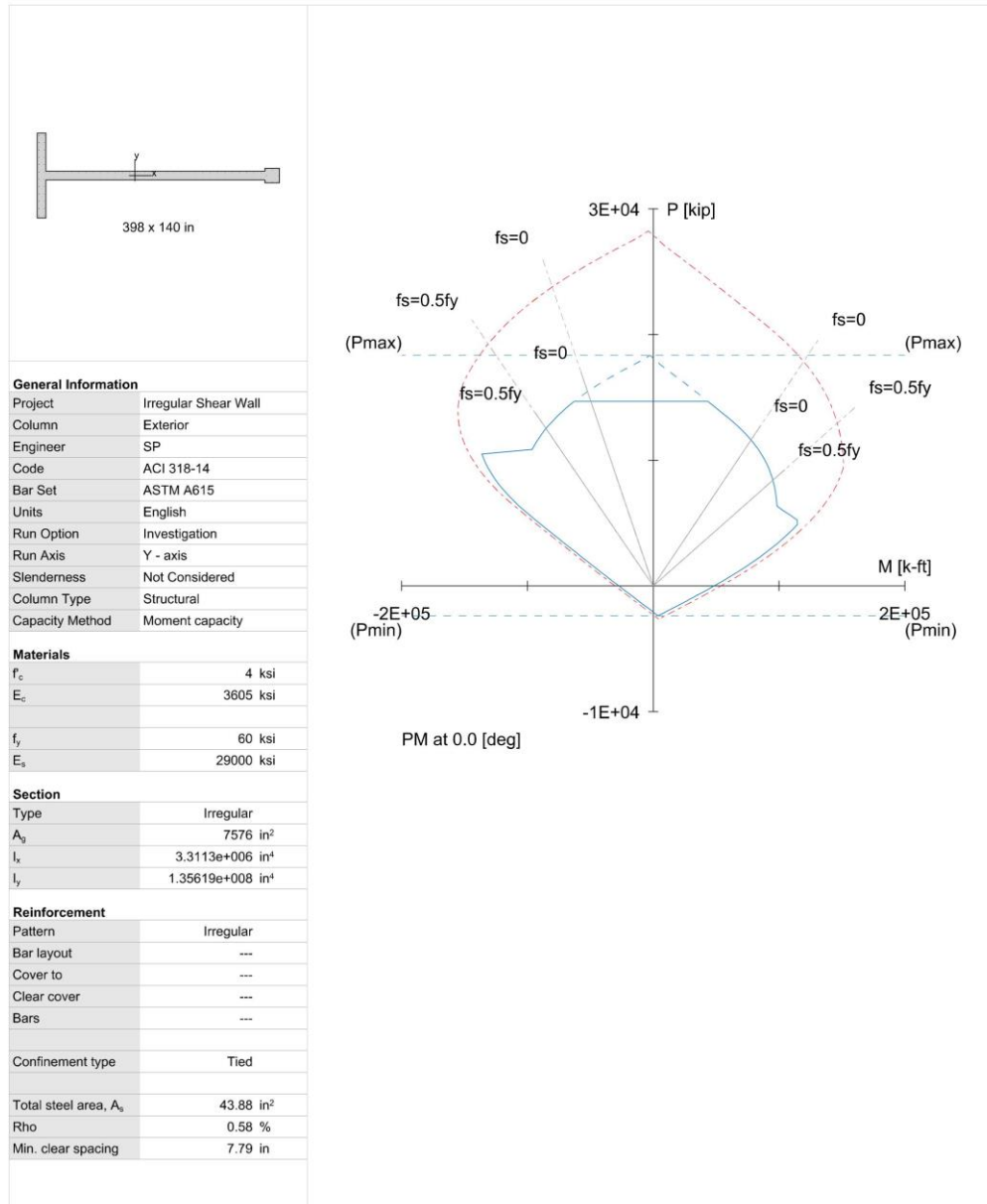

9. Summary and Comparison of Design Results

Table 12 - Comparison of Results				
Moment about Negative Y-Axis				
Support	ϕP_n , kip		ϕM_n , kip-ft	
	Hand	spColumn	Hand	spColumn
Max compression	18,357.3	18,357.3	2,605.20	2,605.14
Allowable compression	14,685.8	14,685.8	---	---
$f_s = 0.0$	15,461.0	15,461.0	52,236.95	52,237.39
$f_s = 0.5 f_y$	12,519.6	12,519.6	85,349.18	85,349.34
Balanced point	10,657.9	10,657.9	97,424.46	97,424.52
Tension control	11,151.1	11,151.1	138,233.70	138,233.70
Pure bending	0.0	0.0	27,407.84	27,406.32
Max tension	2,369.5	2,369.5	3,823.88	3,823.87
Moment about Positive Y-Axis				
Support	ϕP_n , kip		ϕM_n , kip-ft	
	Hand	spColumn	Hand	spColumn
Max compression	18,357.3	18,357.3	2,605.17	2,605.17
Allowable compression	14,685.8	14,685.8	---	---
$f_s = 0.0$	11,614.1	11,614.1	77,723.02	77,723.02
$f_s = 0.5 f_y$	8,417.7	8,417.7	95,118.94	95,118.94
Balanced point	6,299.7	6,299.7	98,452.51	98,452.51
Tension control	5,105.4	5,105.4	116,488.52	116,488.59
Pure bending	0.0	0.0	48,401.33	48,401.51
Max tension	2,369.5	2,369.5	3,823.88	3,823.87

In all of the hand calculations used illustrated above, the results are in precise agreement with the automated exact results obtained from the [spColumn](#) program.

10. Conclusions & Observations

The analysis of the reinforced concrete section performed by [spColumn](#) conforms to the provisions of the Strength Design Method and Unified Design Provisions with all conditions of strength satisfying the applicable conditions of equilibrium and strain compatibility.

In the calculation shown above a P-M interaction diagram was generated with moments about the Y-Axis. Since the section and reinforcement distribution are not symmetrical, a different P-M interaction diagram is required for the other orthogonal direction (where moments are about the X-Axis) (The following Figures illustrate the two conditions for the case where $f_s = f_y$).

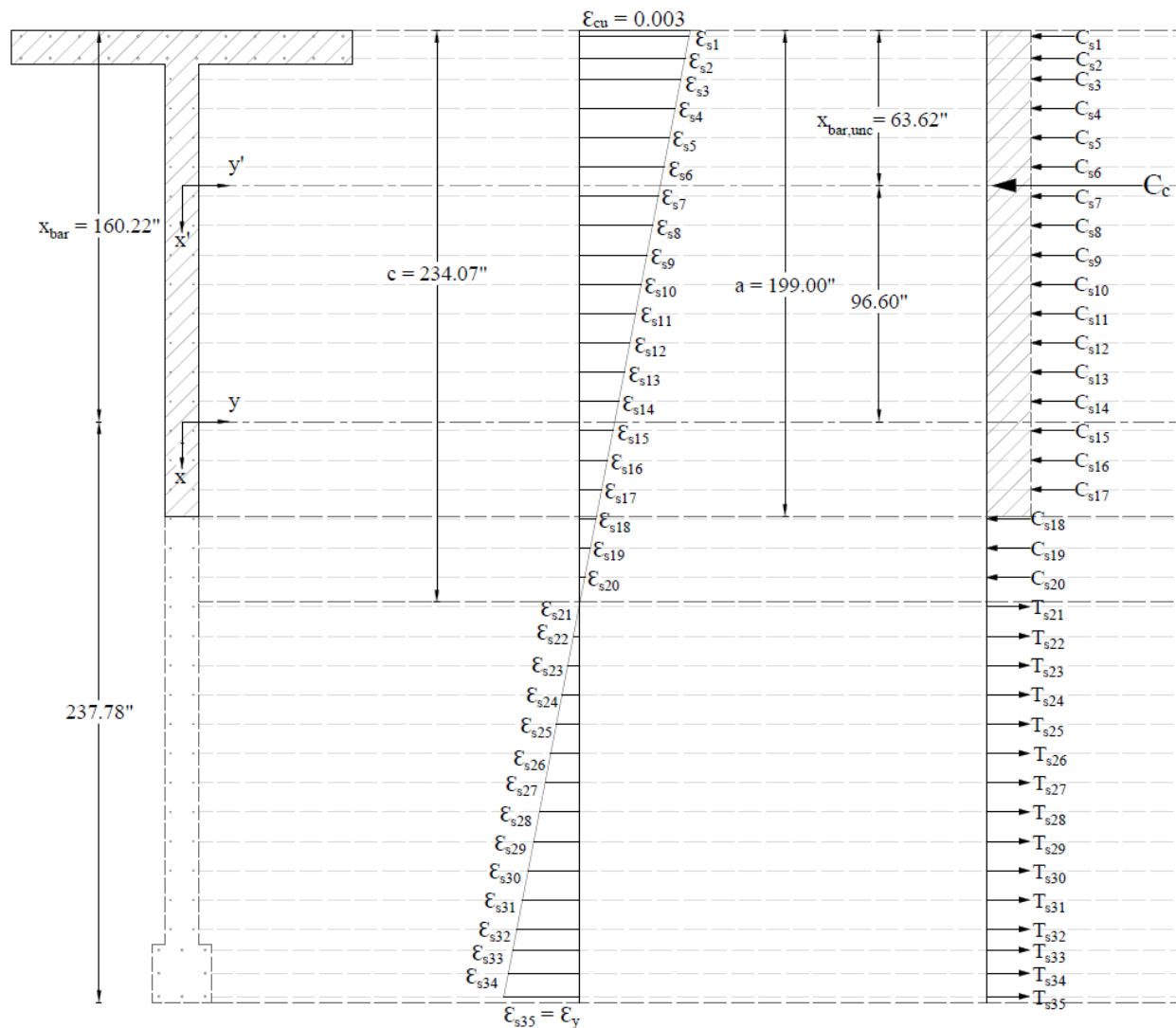

Figure 15 – Strains, Forces, and Moment Arms ($f_s = f_y$ Moments About y-axis)

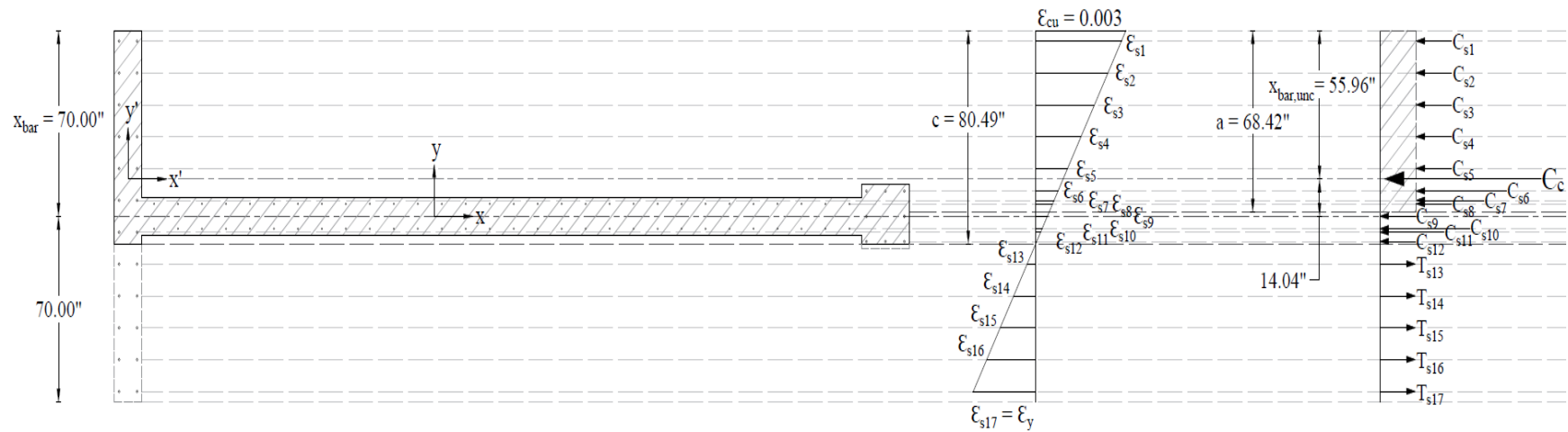

Figure 16 – Strains, Forces, and Moment Arms ($f_s = f_y$, Moments About x-axis)

When running about the X-Axis, 17 layers of reinforcement are participating instead of 35 layers of reinforcement about y-axis resulting in a completely different P-M interaction diagram as shown in the following [spColumn](#) output. The P-M diagram about x-axis is symmetrical since the section is also symmetrical.

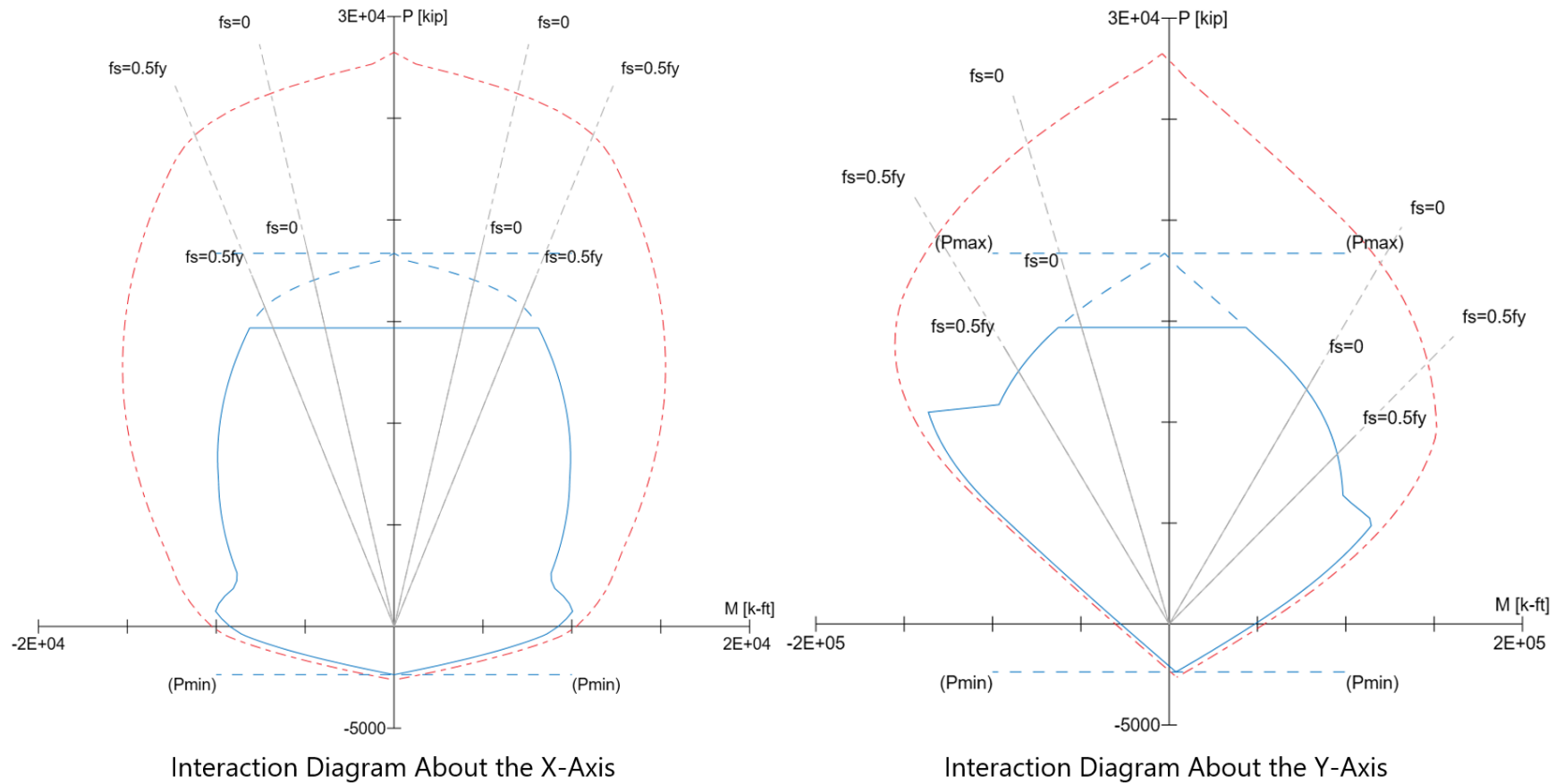

Figure 17 – Comparison of Wall Interaction Diagrams about X-Axis and Y-Axis ([spColumn](#))

In most building design calculations, such as the examples shown in the StructurePoint website, all building columns and walls are subjected to M_x and M_y due to lateral forces and unbalanced moments from both directions of analysis. This requires an evaluation of the column or wall P-M interaction diagram in two directions simultaneously (biaxial bending) instead of the uniaxial investigation illustrated here.

StructurePoint's [spColumn](#) program can also investigate column and wall sections in biaxial mode to produce the results shown in the following Figure for the wall section in this example. In biaxial run mode, M_x and M_y diagrams at each axial force level can be viewed in 2D and 3D views.

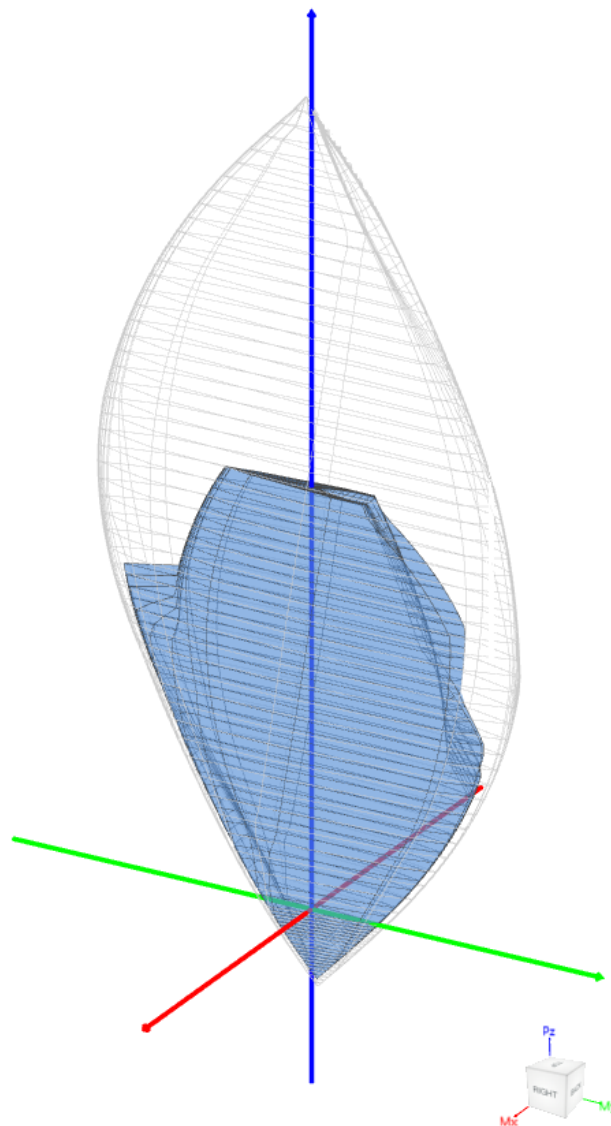
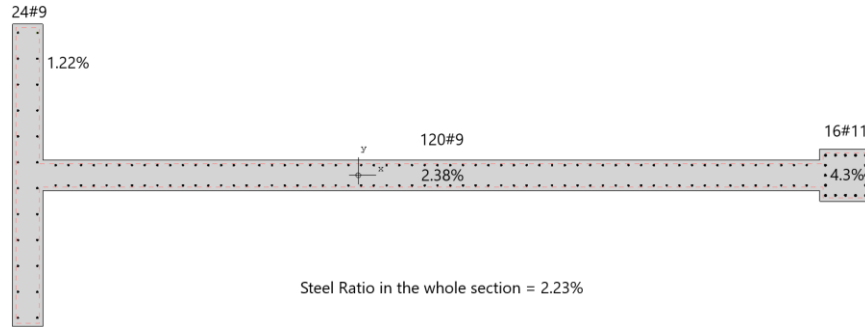

Figure 18 – Nominal & Design 3D Failure Surfaces (Biaxial) (spColumn)

Upon review of the model results, maximum tension strain values for the pure bending control point were deemed too high given the low assumed reinforcement ratio. A revised reinforcement arrangement was implemented as shown below:



About	Point	P	X-Moment	Y-Moment	NA Depth	d _t Depth	ε _t	Φ
		kip	k-ft	k-ft	in	in		
X	@ Max compression	22959	0	18432	438.2	136.0	-0.00207	0.65
X	@ f _s = 0.0	20193	4843	23027	136.0	136.0	0.00000	0.65
X	@ Allowable comp.	18367	7199	28053	110.0	136.0	0.00071	0.65
X	@ f _s = 0.5 f _y	17609	7763	29339	101.1	136.0	0.00103	0.65
X	@ Balanced point	7998	10454	-761	80.5	136.0	0.00207	0.65
X	@ Pure bending	0	10513	-32004	59.7	136.0	0.00384	0.80
X	@ Tension control	-2736	11221	-42613	51.0	136.0	0.00500	0.90
X	@ Max tension	-9124	0	-27054	0.0	136.0	9.99999	0.90
Y	@ Max compression	22959	0	18432	1274.4	395.5	-0.00207	0.65
Y	@ Allowable comp.	18367	0	68733	458.0	395.5	-0.00041	0.65
Y	@ f _s = 0.0	14699	0	107238	395.5	395.5	0.00000	0.65
Y	@ f _s = 0.5 f _y	10512	0	128088	294.1	395.5	0.00103	0.65
Y	@ Balanced point	7353	0	134771	234.1	395.5	0.00207	0.65
Y	@ Tension control	3967	0	163518	148.3	395.5	0.00500	0.90
Y	@ Pure bending	0	0	125111	93.3	395.5	0.00971	0.90
Y	@ Max tension	-9124	0	-27054	0.0	395.5	9.99999	0.90
-X	@ Max compression	22959	0	18432	438.2	136.0	-0.00207	0.65
-X	@ f _s = 0.0	20193	-4843	23027	136.0	136.0	0.00000	0.65
-X	@ Allowable comp.	18367	-7199	28053	110.0	136.0	0.00071	0.65
-X	@ f _s = 0.5 f _y	17609	-7763	29339	101.1	136.0	0.00103	0.65
-X	@ Balanced point	7998	-10454	-761	80.5	136.0	0.00207	0.65
-X	@ Pure bending	0	-10513	-32004	59.7	136.0	0.00384	0.80
-X	@ Tension control	-2736	-11221	-42613	51.0	136.0	0.00500	0.90
-X	@ Max tension	-9124	0	-27054	0.0	136.0	9.99999	0.90
-Y	@ Max compression	22959	0	18432	1273.7	395.3	-0.00207	0.65
-Y	@ Allowable comp.	18367	0	-53836	401.1	395.3	-0.00004	0.65
-Y	@ f _s = 0.0	18157	0	-56787	395.3	395.3	0.00000	0.65
-Y	@ f _s = 0.5 f _y	14025	0	-103534	293.9	395.3	0.00103	0.65
-Y	@ Balanced point	10912	0	-129566	234.0	395.3	0.00207	0.65
-Y	@ Tension control	8884	0	-196773	148.2	395.3	0.00500	0.90
-Y	@ Pure bending	0	0	-142664	26.3	395.3	0.04212	0.90
-Y	@ Max tension	-9124	0	-27054	0.0	395.3	9.99999	0.90

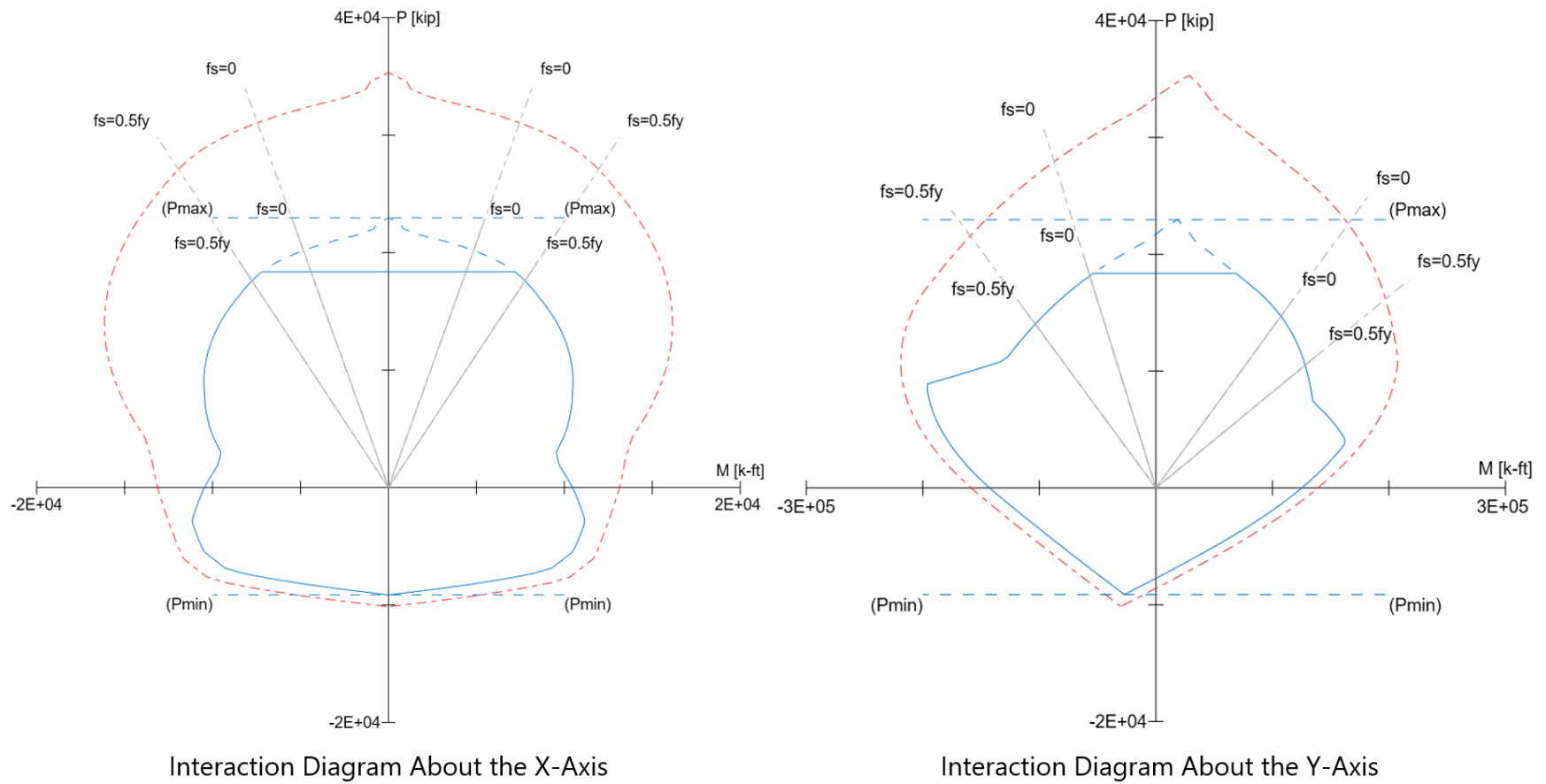

Figure 19 – Comparison of Revised Wall Interaction Diagrams about X-Axis and Y-Axis (spColumn)

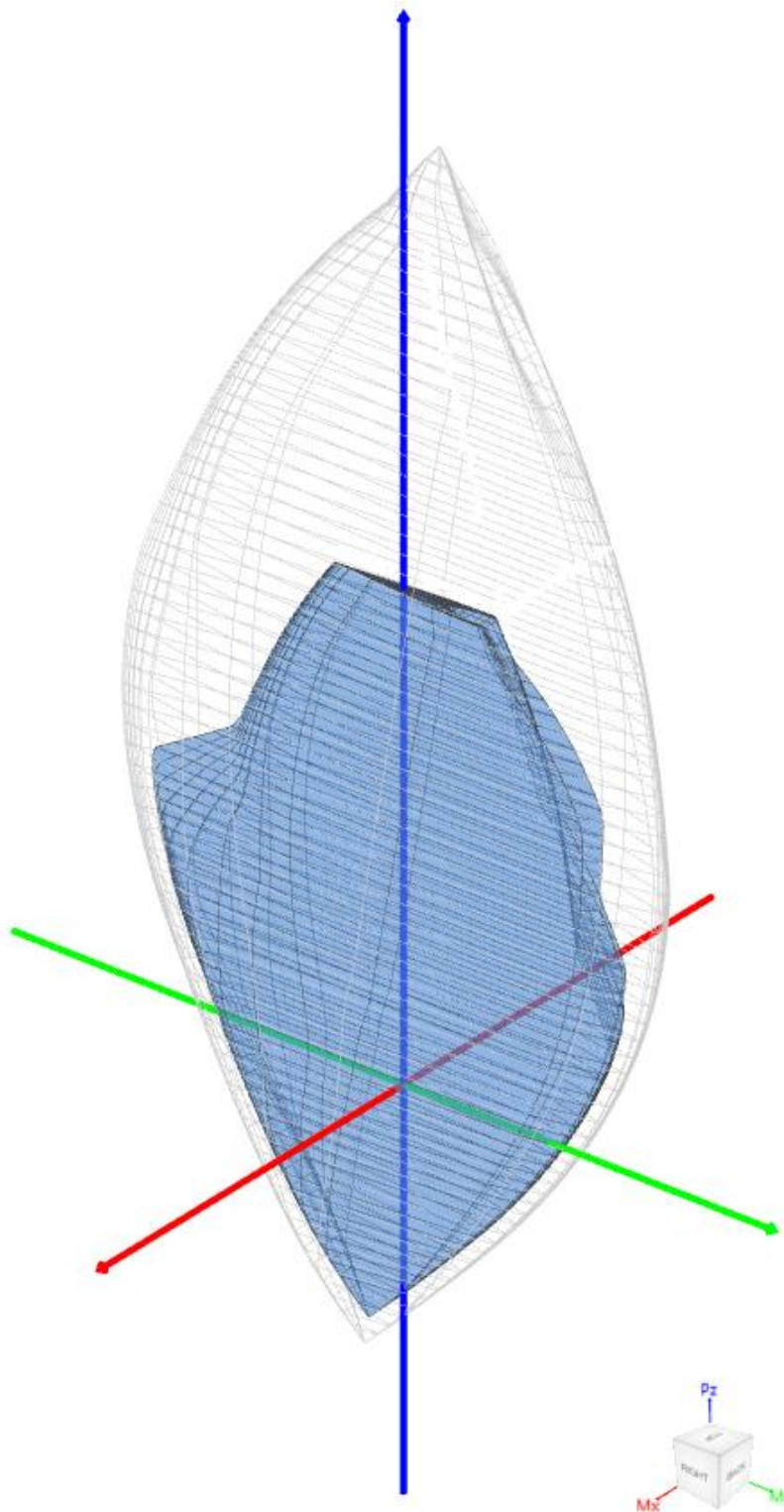

Figure 20 – Revised Wall Nominal & Design 3D Failure Surfaces (Biaxial) (spColumn)

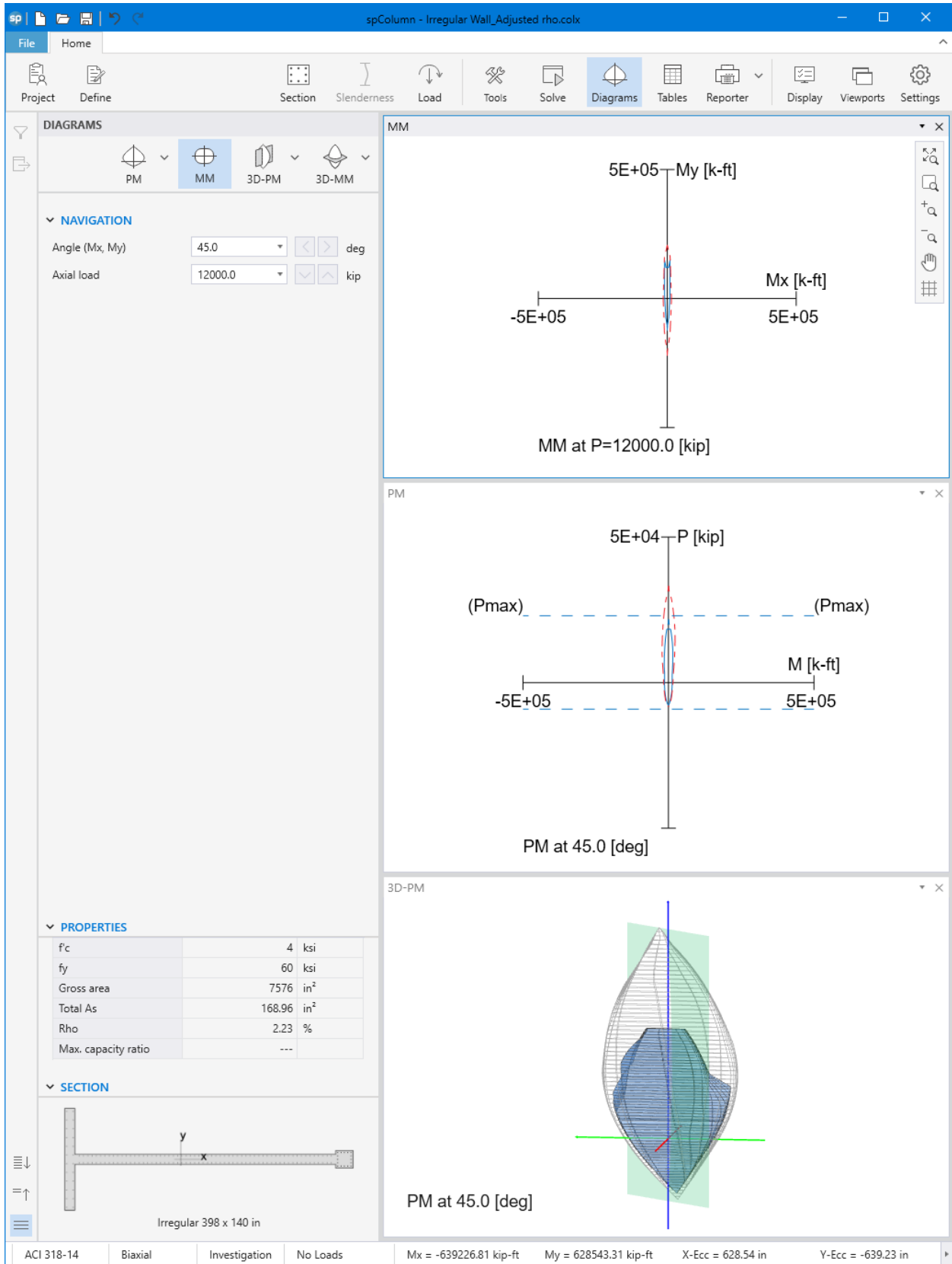

Figure 21 – Revised Wall Interaction Diagram and 3D failure Surface Viewer (spColumn)

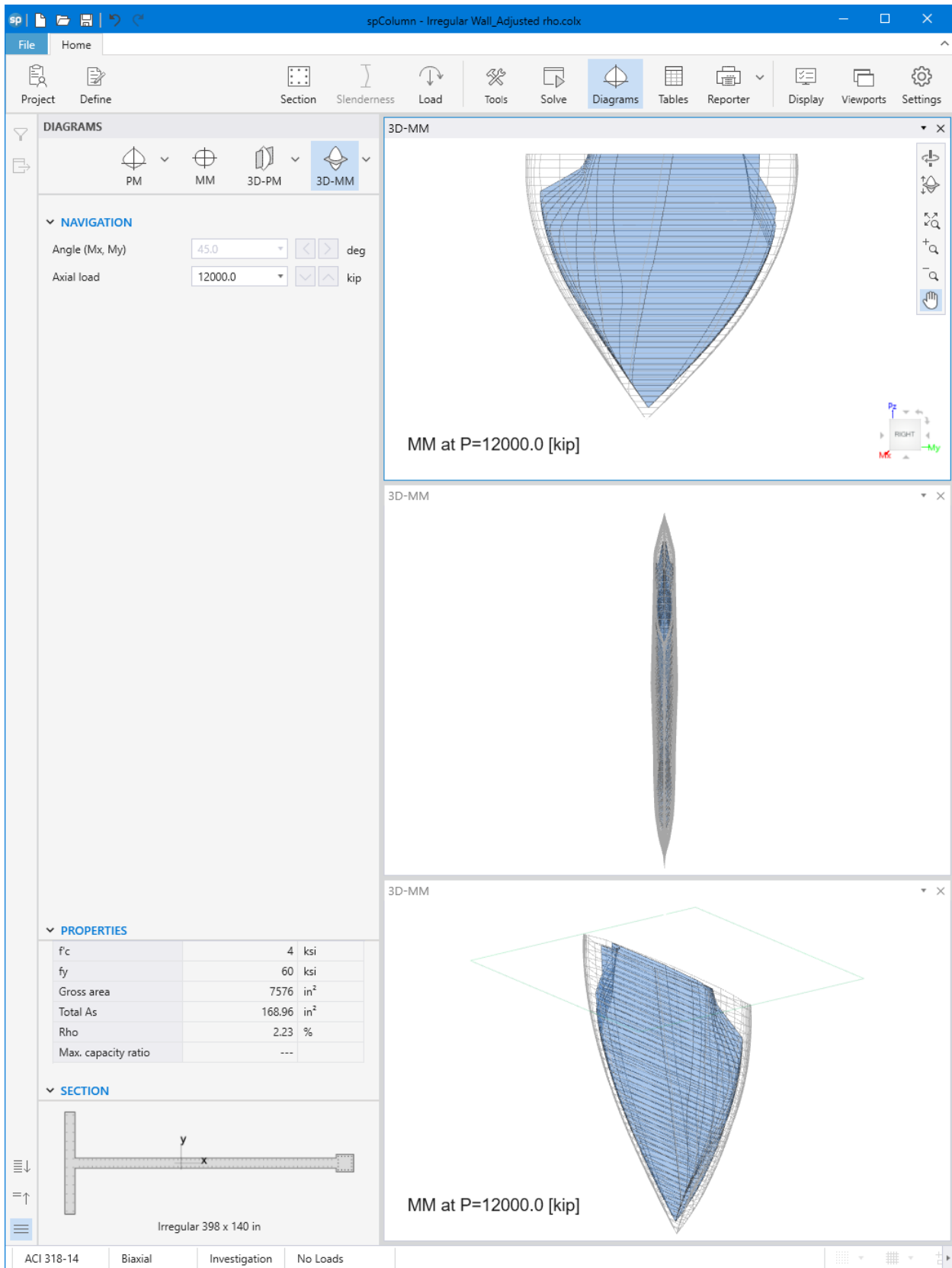

Figure 22 – Revised Wall Failure Surface with a Horizontal Plane Cut at P = 12,000 kip (spColumn)

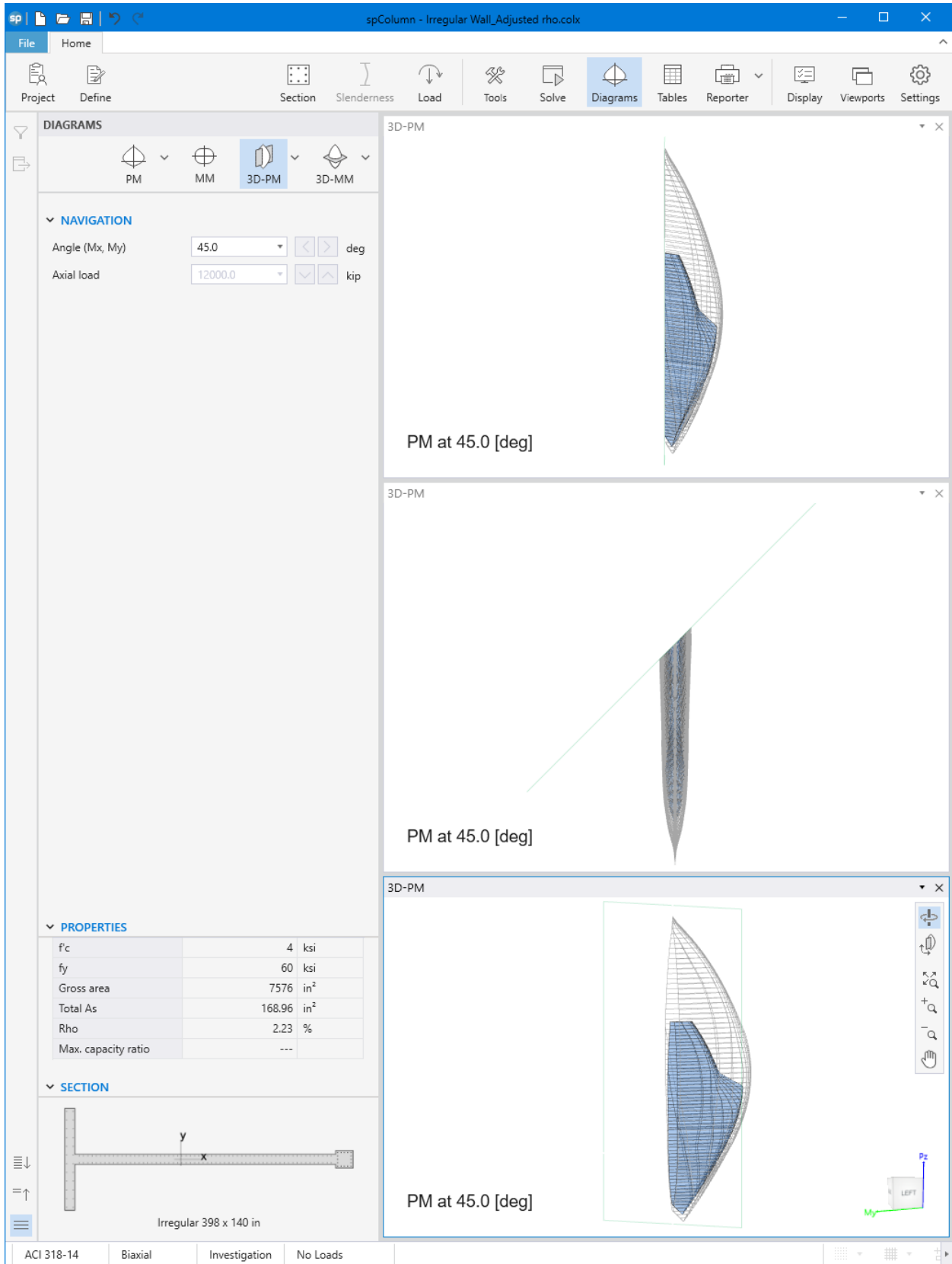

Figure 23 – Revised Wall 3D Failure Surface with a Vertical Plane Cut at 45° (spColumn)