

Reinforced Concrete Bearing Wall Design (CSA A23.3-14)

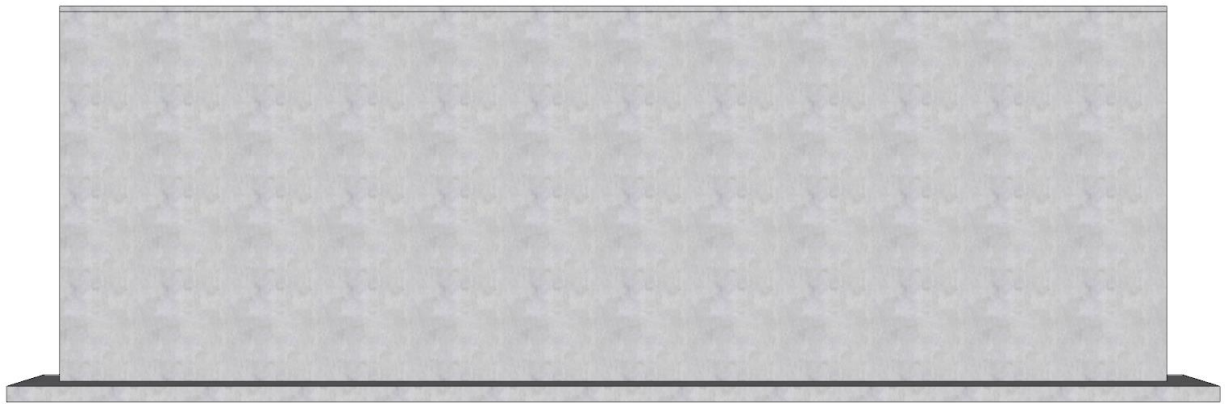
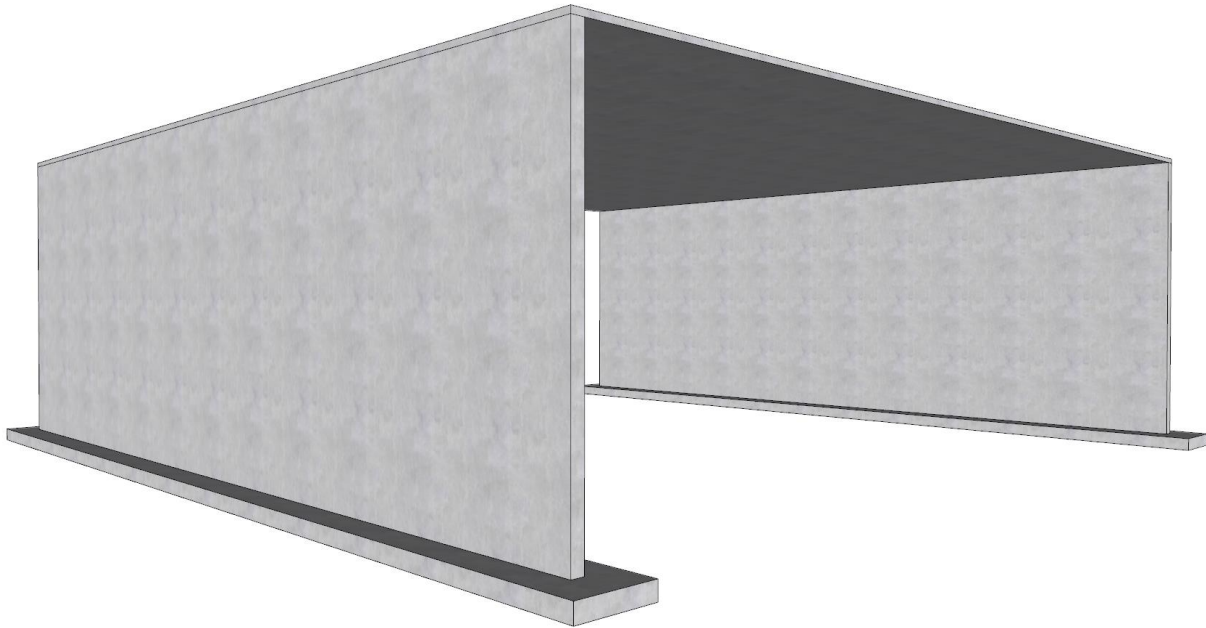

Reinforced Concrete Bearing Wall Design (CSA A23.3-14)

A structural reinforced concrete bearing wall in a single-story building provides gravity load resistance for the following applied loads:

Roof uniform dead load = 120 kN/m

Roof uniform live load = 150 kN/m

The assumed bearing wall section is investigated after analysis to verify suitability for the applied loads then compared with numerical analysis results obtained from [spWall](#) engineering software program from [StructurePoint](#).

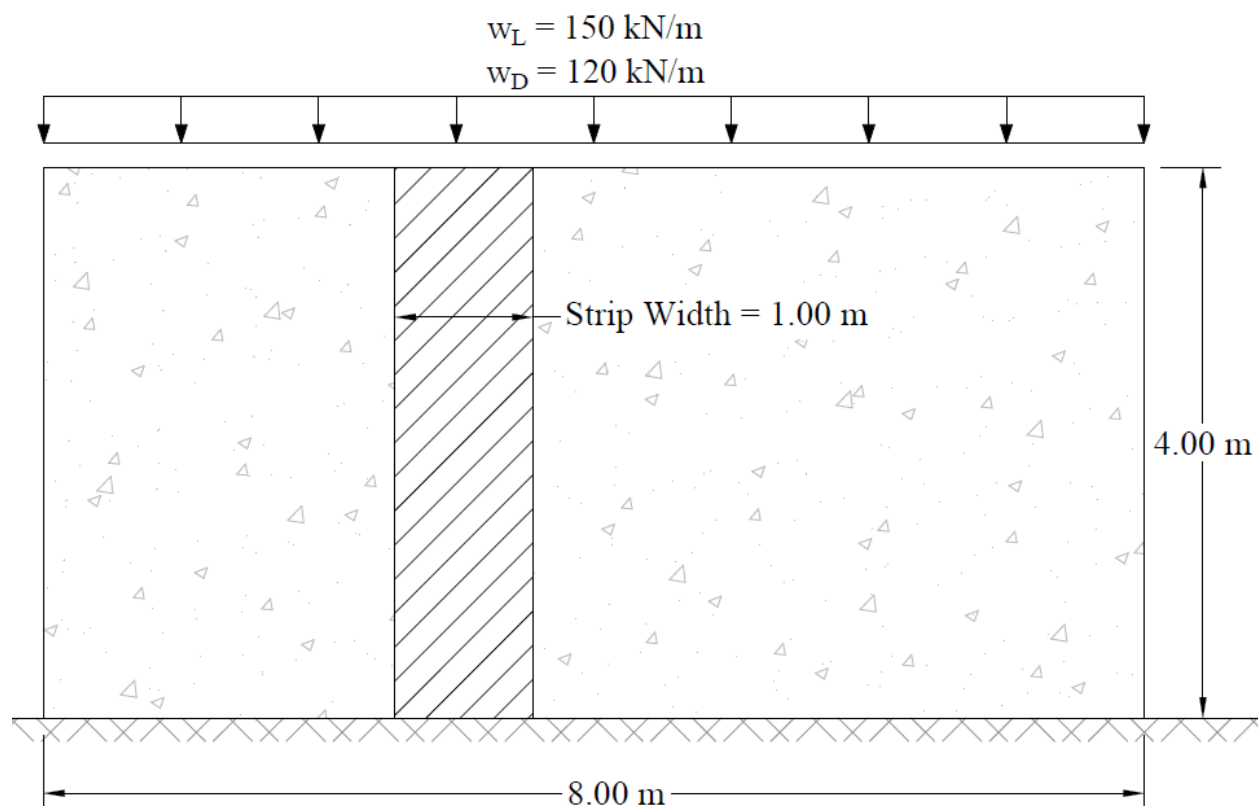

Figure 1 – Reinforced Concrete Bearing Wall Geometry

Contents

1. Simplified Equation Method	2
2. Wall Structural Analysis	2
2.1. Load and Load Combination.....	2
2.2. Preliminary Member Sizing	2
2.3. Calculation of axial resistance	3
2.4. Minimum Horizontal Reinforcement	3
2.5. Minimum Vertical Reinforcement	4
2.6. Check minimum standard requirements.....	4
3. Reinforced Concrete Bearing Wall Analysis and Design – spWall Software	5
4. Design Results Comparison and Conclusions	23

Code

Design of Concrete Structures (CSA A23.3-14) and Explanatory Notes on CSA Group standard A23.3-14 “Design of Concrete Structures”

Reference

- Reinforced Concrete Structures, 2nd Edition, 2018, Omar Chaallal, Presses de l'Université du Québec, Example 13.2
- [spWall Engineering Software Program Manual v10.00, STRUCTUREPOINT, 2022](#)

Design Data

$f_c' = 25$ MPa normal weight concrete ($w_c = 24$ kN/m³)

$f_y = 400$ MPa

Wall height = 4.0 m.

Wall length = 8.0 m.

Used No. 10M bars for vertical and horizontal reinforcement ($A_s = 100$ mm², $d_b = 11.3$ mm)

Clear cover = 40 mm

CSA A23.3-14 (Table 17)

1. Simplified Equation Method

Reinforced concrete bearing walls whether precast or cast in place can be analyzed using the provisions of Chapter 14 of the CSA A23.3-14. Bearing walls, are widely evaluated using the “Simplified Equation Method” in Section 14.2.2 having a simple expression. The applicable requirements of this procedure are summarized below:

- The wall has a solid rectangular constant cross-section over its height CSA A23.3-14 (14.2.2.2a)
The wall in this example has a solid rectangular constant cross-section over its height
- The principal moment acts about the weak axis (axis parallel to the plane of the wall) CSA A23.3-14 (14.2.2.2b)

This condition is not applicable for this wall (no moments are applied on the wall).

- The resultant of the factored axial (vertical) loads, including the effect of the principal moment, is located within the middle third of the total wall thickness CSA A23.3-14 (14.2.2.2c)
This condition is not applicable for this wall (no eccentricity – the factor axial load is applied at the center of the cross-section).

- The wall is supported against lateral displacements, at least along the top and bottom ends CSA A23.3-14 (14.2.2.2d)

The wall in this example is laterally supported at its top and bottom ends.

As a conclusion, the simplified equation method can be used for the wall discussed in this example.

2. Wall Structural Analysis

2.1. Load and Load Combination

For the factored Load

$$w_u = 1.25 \times DL + 1.5 \times LL \quad \text{CSA A23.3-14 (Annex C, Table C.1a)}$$

$$w_u = 1.25 \times 120 + 1.5 \times 150 = 375 \text{ kN/m}$$

2.2. Preliminary Member Sizing

$$t \geq \min \left\{ \begin{array}{l} \frac{l_w}{25} \\ \frac{h_u}{25} \\ 150 \text{ mm} \end{array} \right\} = \min \left\{ \begin{array}{l} \frac{8000}{25} \\ \frac{4000}{25} \\ 150 \end{array} \right\} = \left\{ \begin{array}{l} 320 \\ 160 \\ 150 \end{array} \right\} = 320 \text{ mm} \quad \text{CSA A23.3-14 (14.1.7.1)}$$

Use $t = 350 \text{ mm}$.

2.3. Calculation of axial resistance

The analysis is performed for a unit length (1,000 mm) of the wall.

$$L = 1 \text{ m} = 1000 \text{ mm}$$

$$A_g = L \times t = 1000 \times 350 = 350,000 \text{ mm}^2$$

$$\alpha_1 = 0.85 - 0.0015 f'_c = 0.85 - 0.0015 \times 25 = 0.81 > 0.67$$

CSA A23.3-14 (Eq. 10.1)

$$k = 0.8 \text{ (For walls restrained against rotation at one or both ends)}$$

CSA A23.3-14 (14.2.2.3)

$$P_r = \frac{2}{3} \times \alpha_1 \times \phi_c \times f'_c \times A_g \times \left[1 - \left(\frac{k \times h_u}{32 \times t} \right)^2 \right]$$

CSA A23.3-14 (Eq. 14.1)

$$P_r = \frac{2}{3} \times 0.81 \times 0.65 \times 25 \times 350,000 \times \left[1 - \left(\frac{0.8 \times 4,000}{32 \times 350} \right)^2 \right] / 1 \text{ m} = 2,821 \text{ kN/m}$$

$$P_r = 2,821 \text{ kN/m} > P_f = 375 \text{ kN/m}$$

o.k.

2.4. Minimum Horizontal Reinforcement

Since the wall thickness is more than 210 mm, two layers of reinforcement is required.

$$t = 350 \text{ mm} > 210 \text{ mm} \rightarrow 2 \text{ layers}$$

CSA A23.3-14 (14.1.8.3)

The minimum area for horizontal reinforcement is $A_{h,\min} = 0.002 \times A_g$.

CSA A23.3-14 (14.1.8.6)

$$A_g = 350,000 \text{ mm}^2 \text{ (Calculated in Section 2.3)}$$

$$A_{h,\min} = 0.002 \times 350,000 = 700 \text{ mm}^2$$

Use No. 10M bars ($A_b = 100 \text{ mm}^2$).

$$s_h \leq A_b \times \frac{L}{A_h} = 100 \times \frac{1000}{700} \times 2 = 285.71 \text{ mm}$$

Use 10M @ 250 mm per layer for horizontal reinforcement.

$$s_{\max} = \min \left\{ \begin{array}{l} 3 \times t \\ 500 \end{array} \right\} = \min \left\{ \begin{array}{l} 3 \times 350 \\ 500 \end{array} \right\} = \min \left\{ \begin{array}{l} 1050 \\ 500 \end{array} \right\} = 500 \text{ mm}$$

CSA A23.3-14 (14.1.8.4)

$$s_h = 250 \text{ mm} < s_{\max} = 500 \text{ mm}$$

o.k.

2.5. Minimum Vertical Reinforcement

The minimum area for vertical reinforcement is $A_{v,\min} = 0.0015 \times A_g$. CSA A23.3-14 (14.1.8.5)

$$A_{v,\min} = 0.0015 \times 350,000 = 525 \text{ mm}^2$$

Use No. 10M bars ($A_b = 100 \text{ mm}^2$).

$$s_v \leq A_b \times \frac{L}{A_v} = 100 \times \frac{1000}{525} \times 2 = 380.95 \text{ mm}$$

Use 10M @ 350 mm per layer for vertical reinforcement.

$$s_{\max} = \min \left\{ \begin{array}{l} 3 \times t \\ 500 \end{array} \right\} = \min \left\{ \begin{array}{l} 3 \times 350 \\ 500 \end{array} \right\} = \min \left\{ \begin{array}{l} 1050 \\ 500 \end{array} \right\} = 500 \text{ mm} \quad \text{CSA A23.3-14 (14.1.8.4)}$$

$$s_v = 350 \text{ mm} < s_{\max} = 500 \text{ mm} \quad \text{o.k.}$$

2.6. Check minimum standard requirements

$$d_b \leq \frac{t}{10} \quad \text{CSA A23.3-14 (14.1.8.2)}$$

$$d_{b,\max} = \frac{350}{10} = 35 \text{ mm}$$

For No. 10M bars ($d_b = 11.3 \text{ mm}$)

$$d_b = 11.3 \text{ mm} < d_{b,\max} = 35 \text{ mm} \quad \text{o.k.}$$

Use 2-15M at each end of the wall, due to the concentrated vertical load. CSA A23.3-14 (14.1.8.8.1)

3. Reinforced Concrete Bearing Wall Analysis and Design – [spWall](#) Software

[spWall](#) is a program for the analysis and design of reinforced concrete shear walls, tilt-up walls, cast-in-place walls, precast walls, and Insulate Concrete Form (ICF) walls. It uses a graphical interface that enables the user to easily generate complex wall models. Graphical user interface is provided for:

- Wall geometry (including any number of openings and stiffeners)
- Material properties including cracking coefficients
- Wall loads (point, line, and area),
- Support conditions (including translational and rotational spring supports)

[spWall](#) uses the Finite Element Method for the structural modeling, analysis, and design of slender and non-slender reinforced concrete walls subject to static loading conditions. The wall is idealized as a mesh of rectangular plate elements and straight-line stiffener elements. Walls of irregular geometry are idealized to conform to geometry with rectangular boundaries. Plate and stiffener properties can vary from one element to another but are assumed by the program to be uniform within each element.

Six degrees of freedom exist at each node: three translations and three rotations relating to the three Cartesian axes. An external load can exist in the direction of each of the degrees of freedom. Sufficient number of nodal degrees of freedom should be restrained in order to achieve stability of the model. The program assembles the global stiffness matrix and load vectors for the finite element model. Then, it solves the equilibrium equations to obtain deflections and rotations at each node. Finally, the program calculates the internal forces and internal moments in each element. At the user's option, the program can perform second order analysis. In this case, the program takes into account the effect of in-plane forces on the out-of-plane deflection with any number of openings and stiffeners.

In [spWall](#), the required flexural reinforcement is computed based on the selected design standard (CSA A23.3-14 is used in this example), and the user can specify one or two layers of wall reinforcement. In stiffeners and boundary elements, [spWall](#) calculates the required shear and torsion steel reinforcement. Wall concrete strength (in-plane and out-of-plane) is calculated for the applied loads and compared with the code permissible shear capacity.

For illustration and comparison purposes, the following figures provide a sample of the input modules and results obtained from an [spWall](#) model created for the reinforced concrete bearing wall in this example.

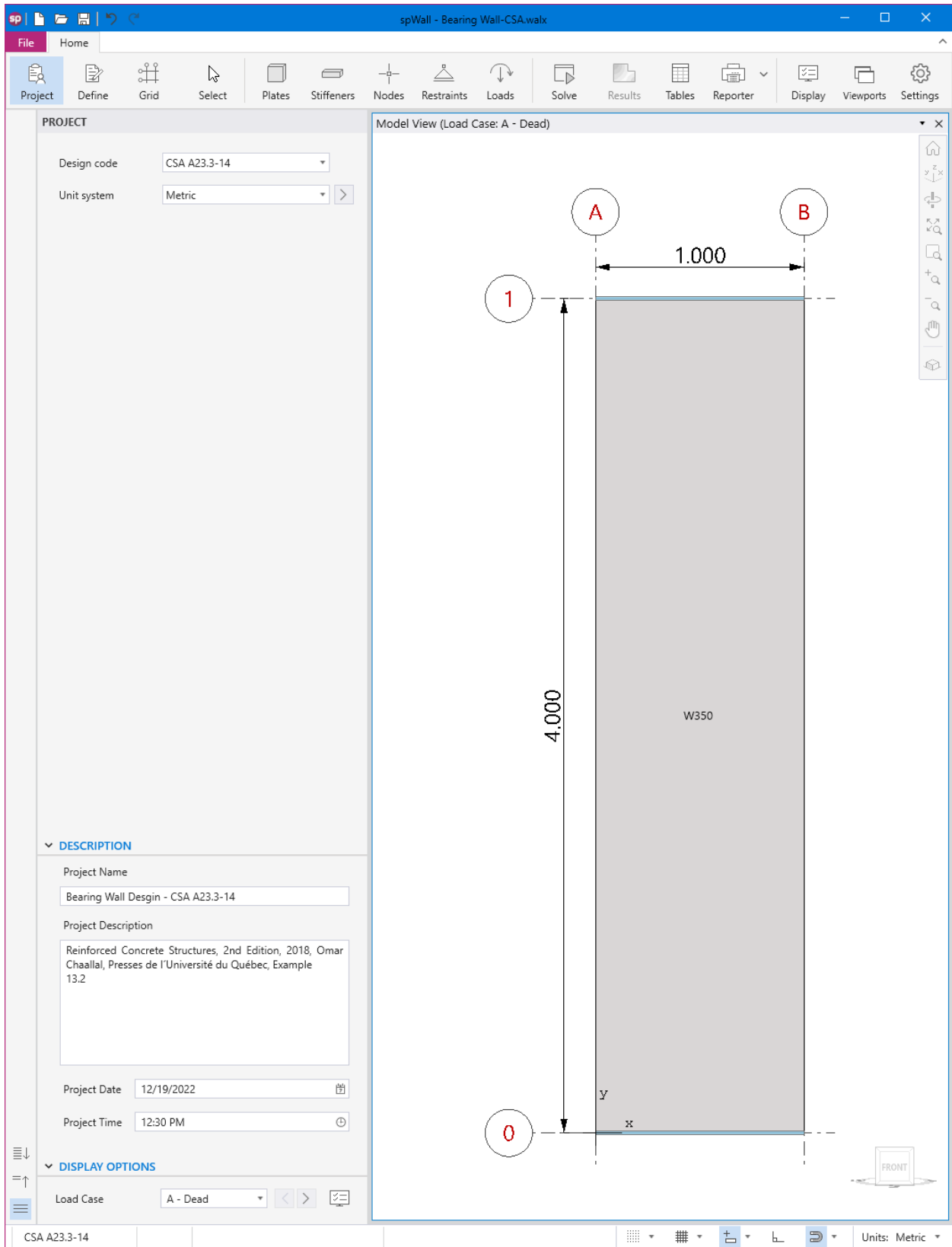

Figure 2 – spWall Interface

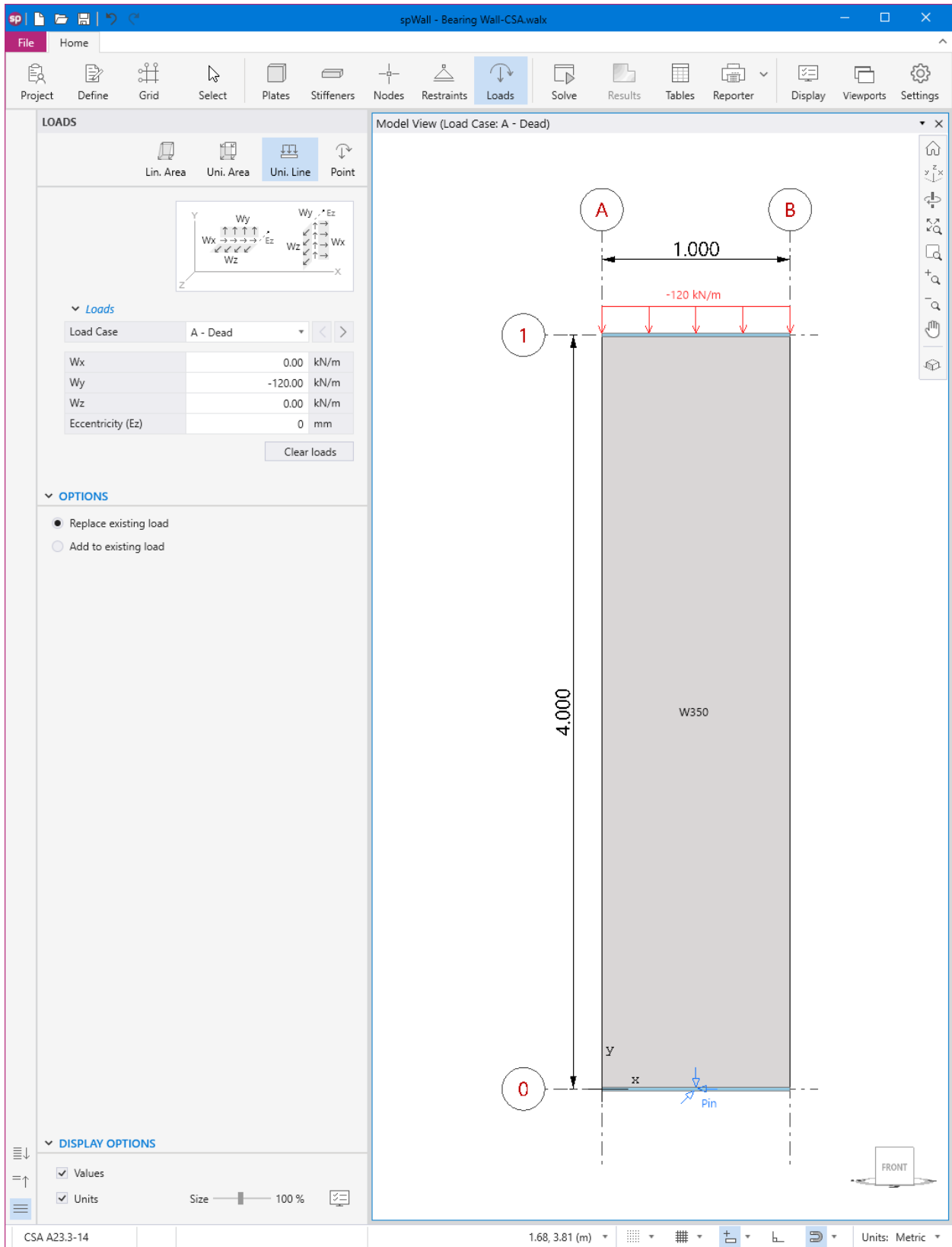

Figure 3 – Assigning Dead Loads for Bearing Wall (spWall)

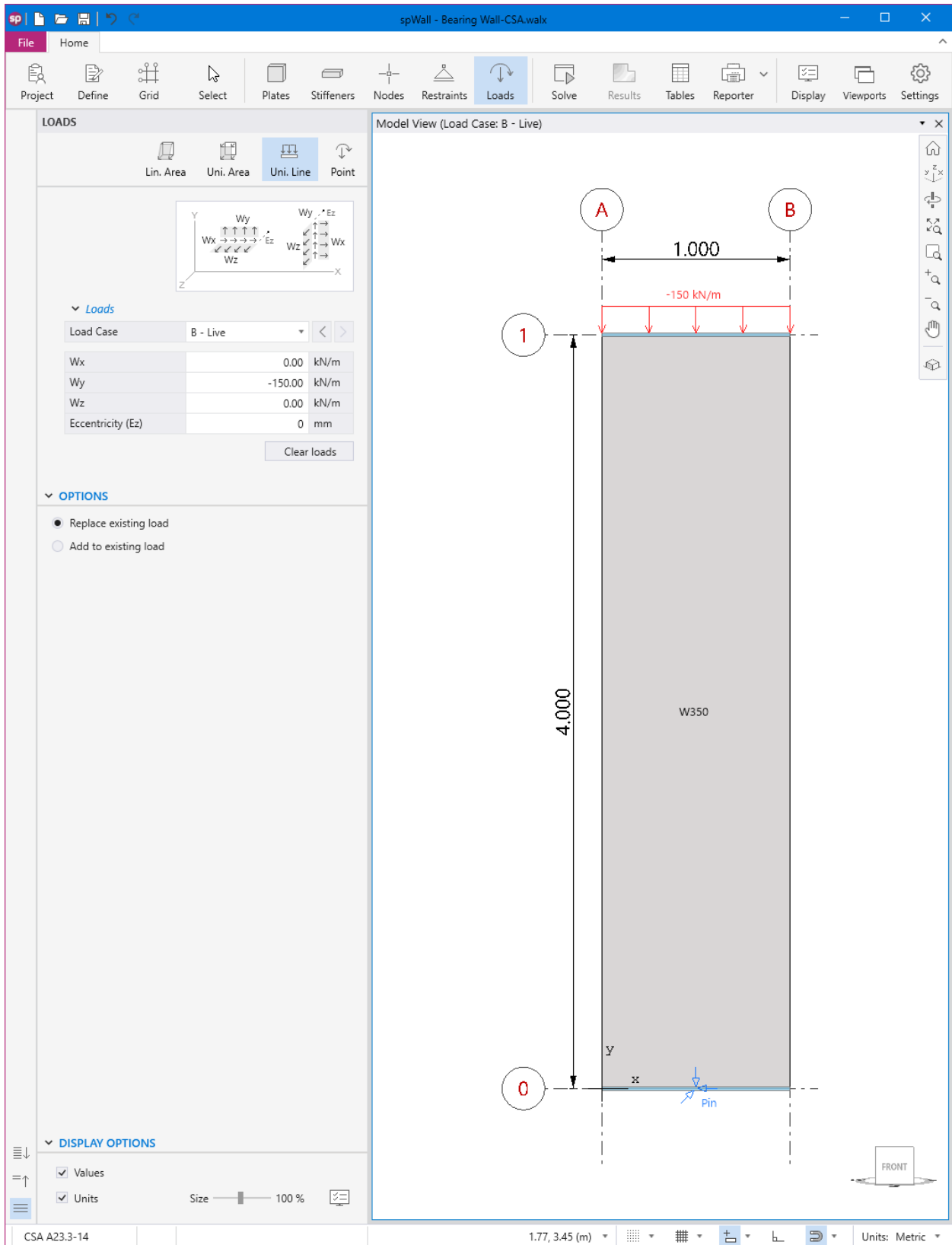

Figure 4 – Assigning Live Loads for Bearing Wall (spWall)

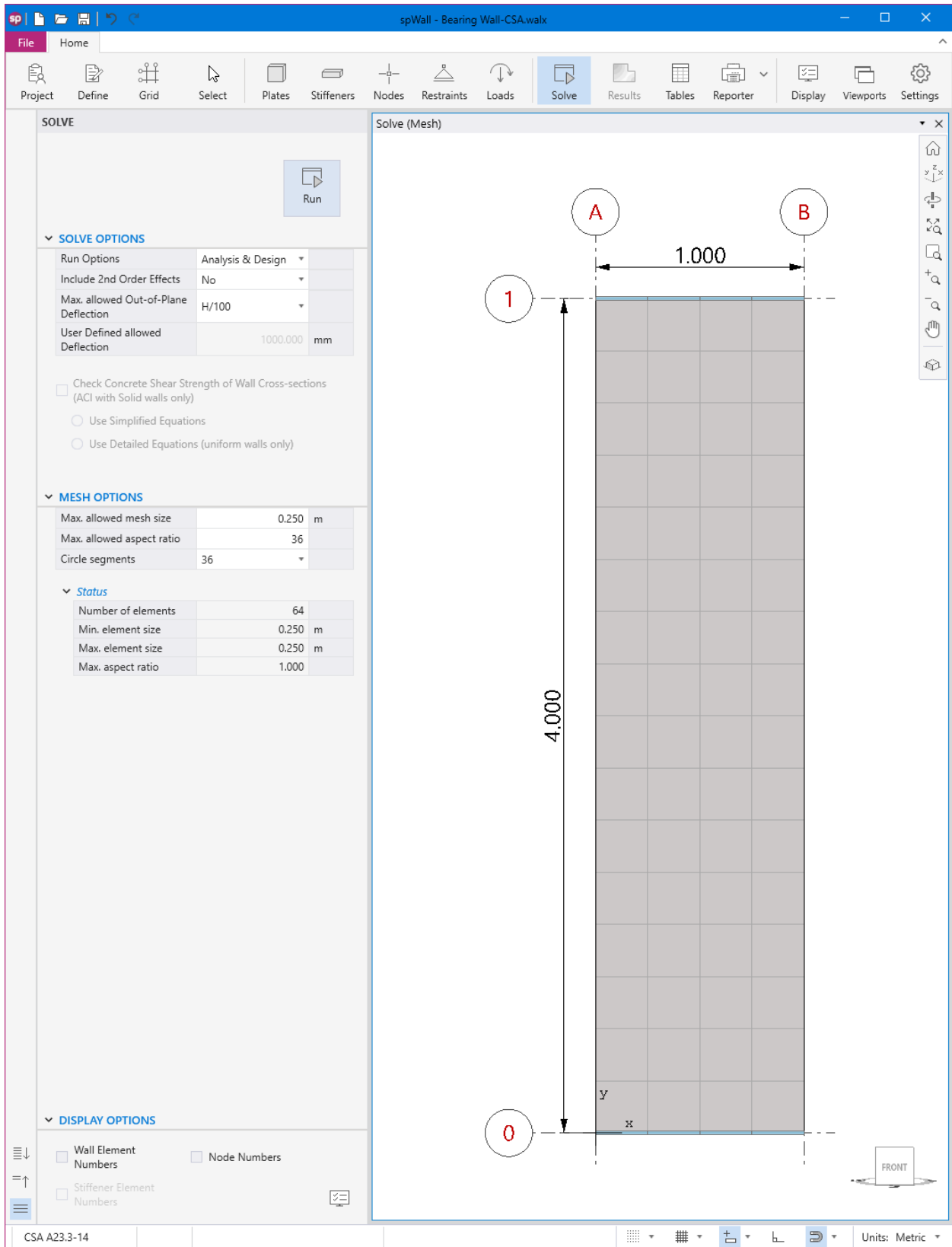

Figure 5 – Solve and Mesh Options (spWall)

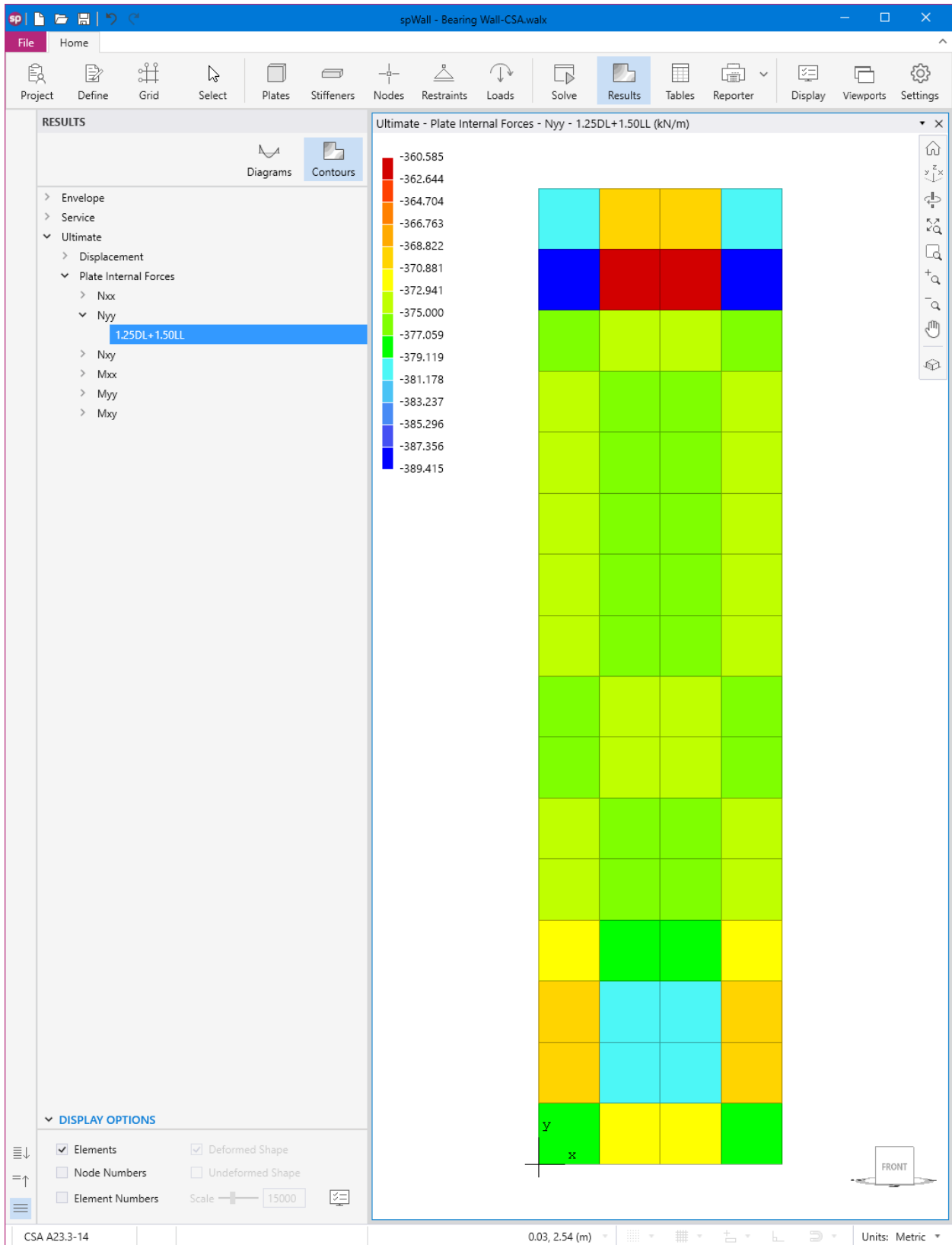

Figure 6 – Factored Axial Forces Contour Normal to Reinforced Concrete Bearing Wall Cross-Section (spWall)

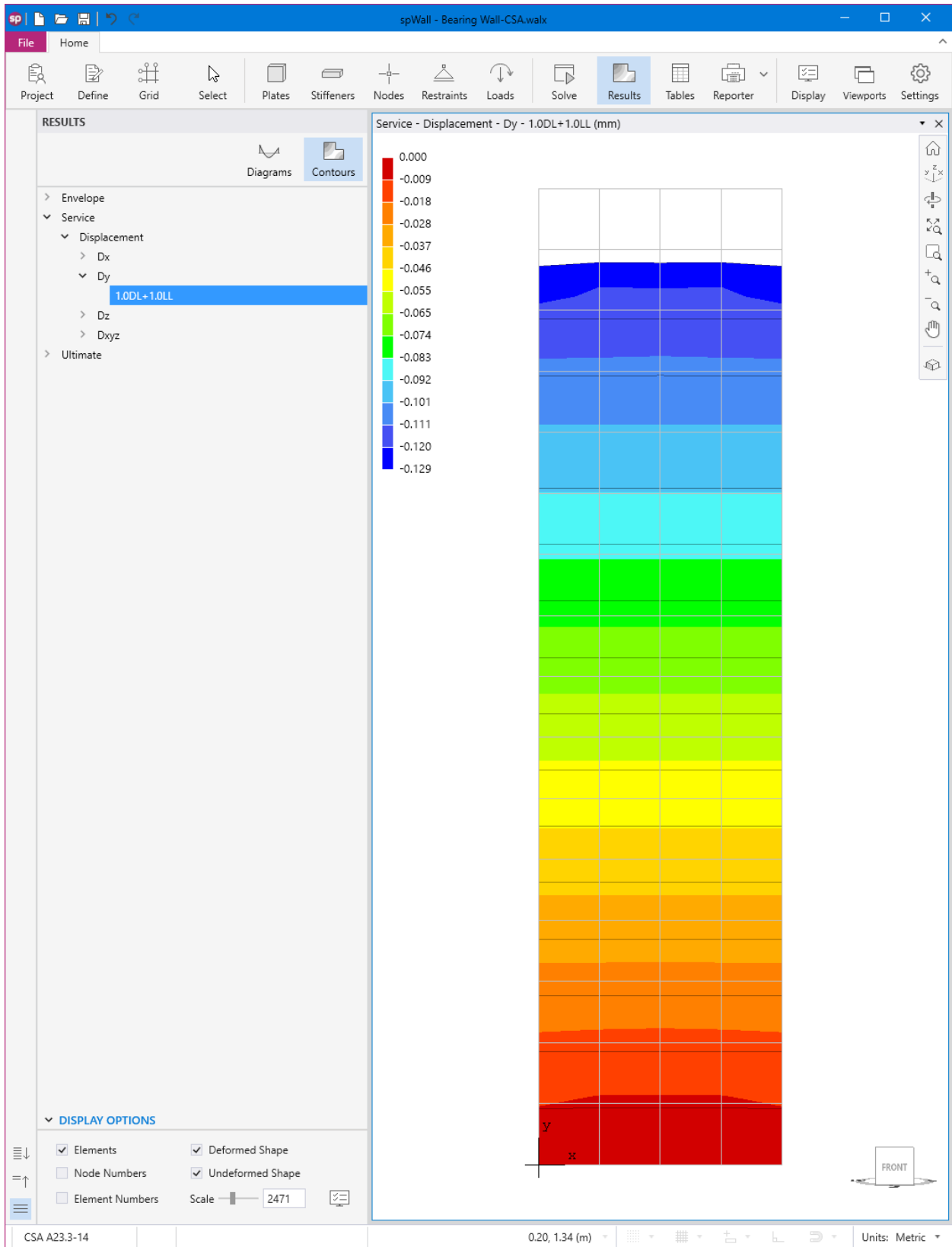

Figure 7 – Reinforced Concrete Bearing Wall Vertical Displacement Contour (In-Plane) (spWall)

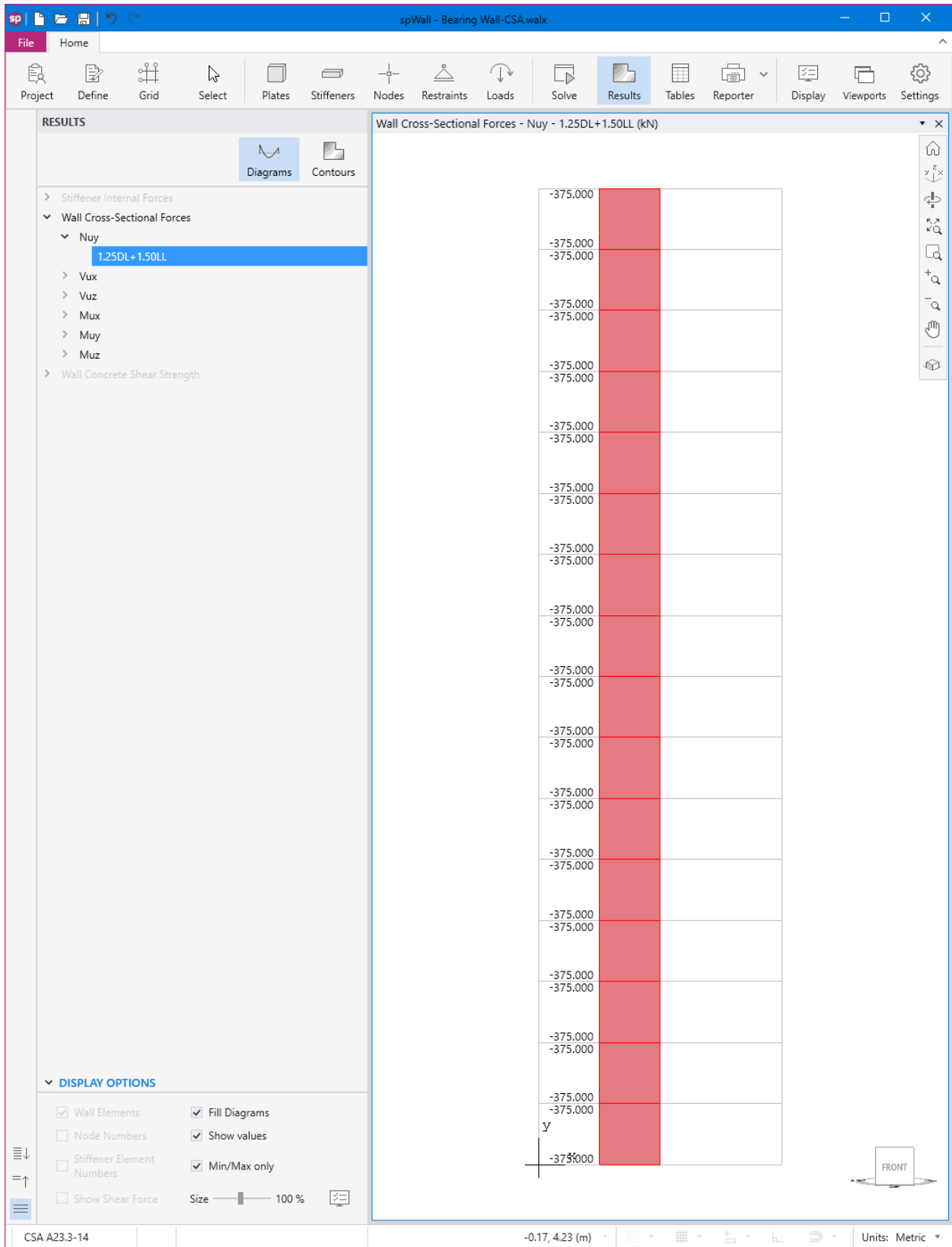
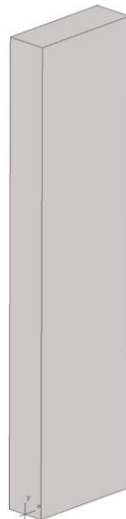

Figure 8 – Reinforced Concrete Bearing Wall Axial Load Diagram (spWall)



spWall v10.00 (TM)
A Computer Program for Analysis and Design of Reinforced Concrete, Precast, and Tilt-up Walls
Copyright © 1988-2022, STRUCTUREPOINT, LLC.
All rights reserved



StructurePoint
Licensee stated above acknowledges that STRUCTUREPOINT (SP) is not and cannot be responsible for either the accuracy or adequacy of the material supplied as input for processing by the spWall computer program. Furthermore, STRUCTUREPOINT neither makes any warranty expressed nor implied with respect to the correctness of the output prepared by the spWall program. Although STRUCTUREPOINT has endeavored to produce spWall error free the program is not and cannot be certified infallible. The final and only responsibility for analysis, design and engineering documents is the licensee's. Accordingly, STRUCTUREPOINT disclaims all responsibility in contract, negligence or other tort for any analysis, design or engineering documents prepared in connection with the use of the spWall program. Licensed to: StructurePoint, LLC. License ID: 00000-0000000-4-20FC1-20FC1

Contents

1. Project	3
1.1. General Information	3
1.2. Solver Options	3
2. Definitions	3
2.1. Grid Lines	3
2.1.1. Vertical	3
2.1.2. Horizontal	3
2.2. Objects	3
2.2.1. Plates	3
2.3. Properties	3
2.3.1. Concrete	3
2.3.2. Reinforcement	3
2.3.3. Plate Cracking Coefficients	4
2.3.4. Plate Design Criteria	4
2.4. Restraints	4
2.4.1. Supports	4
2.5. Load Case/Combo	4
2.5.1. Load Cases	4
2.5.2. Load Combinations	4
3. Assignments	4
3.1. Plates	4
3.2. Stiffeners	4
3.3. Uniform Line Loads	5
4. Results	5
4.1. Envelope	5
4.1.1. Plate Flexure Reinforcement	5
4.2. Ultimate	5
4.2.1. Plate Internal Forces	5
4.2.1.1. 1.25DL+1.50LL	5
5. Screenshots	6
5.1. Extrude 3D view	6
5.2. Plates & Stiffeners ID	7
5.3. Restraints	8
5.4. Loads - Case A - Dead	9
5.5. Loads - Case B - Live	10

STRUCTUREPOINT - spWall v10.00 (TM)
Licensed to: StructurePoint, LLC. License ID: 00000-0000000-4-20FC1-20FC1
E:\StructurePoint\spWall\Bearing Wall-CSA.walx

Page | 3
12/19/2022
1:11 PM

1. Project

1.1. General Information

File Name	Bearing Wall-CSA.walx
Project	Bearing Wall Desgin - CSA A23.3-14
Code	CSA A23.3-14
Units	Metric
Date	12/19/2022
Time	12:30 PM

1.2. Solver Options

Include 2nd order effects	No
Check out-of-plane service deflections	Yes
Maximum permissible out-of-plane deflections	40.000 mm
Check concrete shear strength of wall crossection	No

2. Definitions

2.1. Grid Lines

2.1.1. Vertical

Label	Coordinate-X m	Spacing m
A	0.000	0.000
B	1.000	1.000

2.1.2. Horizontal

Label	Coordinate-Y m	Spacing m
0	0.000	0.000
1	4.000	4.000

2.2. Objects

2.2.1. Plates

Label	Thickness mm	Concrete	Reinforcement	Design Criteria	Cracking Coeff.	Used
W350	350	C25	Gr60	2C#4	PCC1	Yes

2.3. Properties

2.3.1. Concrete

Label	f_c MPa	W_c kg/m ³	E_c MPa	ν -	Precast	Used
C25	25.000	2400.0	24942.6	0.20	No	Yes

2.3.2. Reinforcement

Label	f_y MPa	E_s MPa	Used	Label	f_y MPa	E_s MPa	Used
Gr60	400.000	200000.0	Yes				

STRUCTUREPOINT - spWall v10.00 (TM)
Licensed to: StructurePoint, LLC. License ID: 00000-0000000-4-20FC1-20FC1
E:\StructurePoint\spWall\Bearing Wall-CSA.walx

Page | 4
12/19/2022
1:11 PM

2.3.3. Plate Cracking Coefficients

Label	Service Combinations		Ultimate Combinations		Used
	In-plane	Out-of-plane	In-plane	Out-of-plane	
PCC1	1	0.7	1	0.35	Yes

2.3.4. Plate Design Criteria

NOTE: Bar centroid location measured from Z-ve face for Back Curtain and Z+ve face for Front Curtain

Label	Curtains	Flags	Reinforcement Ratio				Reinforcement Location				Used
			Rmin (Hor) %	Rmax (Hor) %	Rmin (Ver) %	Rmax (Ver) %	Back H. (BH) mm	Back V. (BV) mm	Front H. (FH) mm	Front V. (FV) mm	
2C#4	2		0.20	8.00	0.15	8.00	46	57	46	57	Yes

2.4. Restraints

2.4.1. Supports

Label	Translations			Rotations			Used
	Dx	Dy	Dz	Rx	Ry	Rz	
Pin	Fixed	Fixed	Fixed	Free	Free	Free	Yes

2.5. Load Case/Combo.

2.5.1. Load Cases

NOTE: Self weight is not included under Case A.

Case	Type	Case Label	Load Defined?
A	Dead	Dead	Yes
B	Live	Live	Yes

2.5.2. Load Combinations

Combo./Case	A	B	C	D	E	F	G	H	I	Combo Type
Type	Dead	Live								
Combo./Label	Dead	Live								
1.0DL+1.0...	1.000	1.000	-	-	-	-	-	-	-	Ser.
1.25DL+1....	1.250	1.500	-	-	-	-	-	-	-	Ult.

3. Assignments

3.1. Plates

ID	Label	Shape	Top Left/Center X m	Top Left/Center Y m	Width (B) m	Height (H)/Dia. (D) m
P1	W350	Polygonal	0.500	2.000	1.000	4.000

3.2. Stiffeners

ID	Label	Direction	Start X m	End X m	Start Y m	End Y m	Length m	Rigid Support
S1	- Null -	Horizontal	0.000	1.000	0.000	0.000	1.000	Pin
S2	- Null -	Horizontal	0.000	1.000	4.000	4.000	1.000	

3.3. Uniform Line Loads

Stiffener ID	Load Case	Wx kN/m	Wy kN/m	Wz kN/m	Ecc. mm
S2	A	0.00	-120.00	0.00	0
	B	0.00	-150.00	0.00	0

$$A_{v,avg} = 525 \text{ mm}^2$$

4. Results

4.1. Envelope

4.1.1. Plate Flexure Reinforcement

Coordinate System: Global

Element	Curtains	Direction	Mf (x/y) kNm/m	Nf (x/y) Ld Comb. kN/m	As (x/y) mm ² /m	Rho %	Tie
1	2	Horizontal	0.00	-99.85 1.25DL+1.50L...	700	0.20	
		Vertical	0.00	-393.81 1.25DL+1.50L...	525	0.15	
2	2	Horizontal	0.00	-59.16 1.25DL+1.50L...	700	0.20	
		Vertical	0.00	-381.99 1.25DL+1.50L...	525	0.15	
3	2	Horizontal	0.00	-59.16 1.25DL+1.50L...	700	0.20	
		Vertical	0.00	-381.99 1.25DL+1.50L...	525	0.15	
4	2	Horizontal	0.00	-99.85 1.25DL+1.50L...	700	0.20	
		Vertical	0.00	-393.81 1.25DL+1.50L...	525	0.15	

$$A_{h,avg} = 700 \text{ mm}^2$$

4.2. Ultimate

4.2.1. Plate Internal Forces

4.2.1.1. 1.25DL+1.50LL

Coordinate System: Global

Element	Nxx kN/m	Nyy kN/m	Nxy kN/m	Mxx kNm/m	Myy kNm/m	Mxy kNm/m
1	-83.96	-377.92	15.89	0.00	0.00	0.00
2	-49.25	-372.08	9.91	0.00	0.00	0.00
3	-49.25	-372.08	-9.91	0.00	0.00	0.00
4	-83.96	-377.92	-15.89	0.00	0.00	0.00

$$N_{yy,avg} = 375 \text{ kN}$$

5. Screenshots

5.1. Extrude 3D view

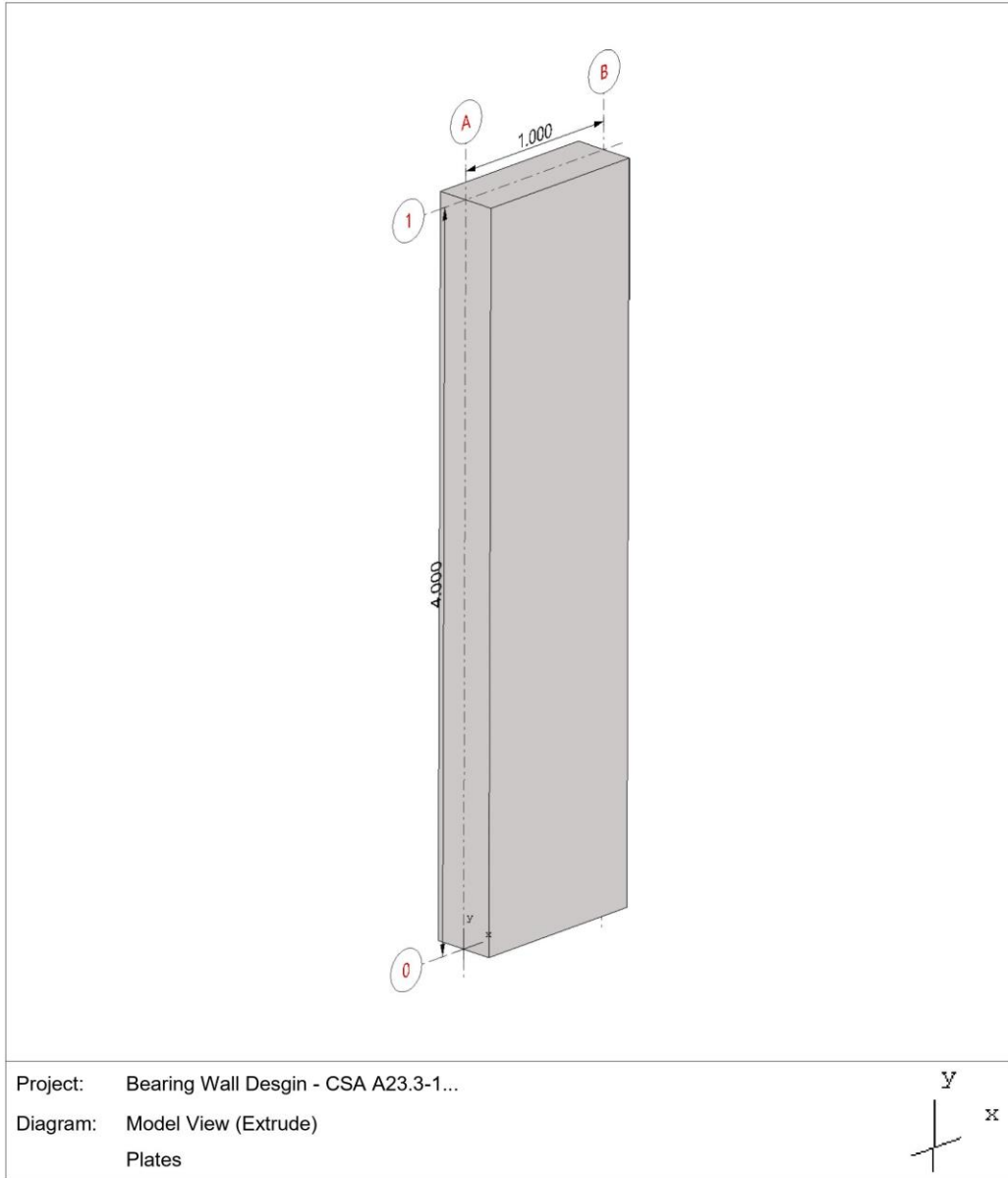

5.2. Plates & Stiffeners ID

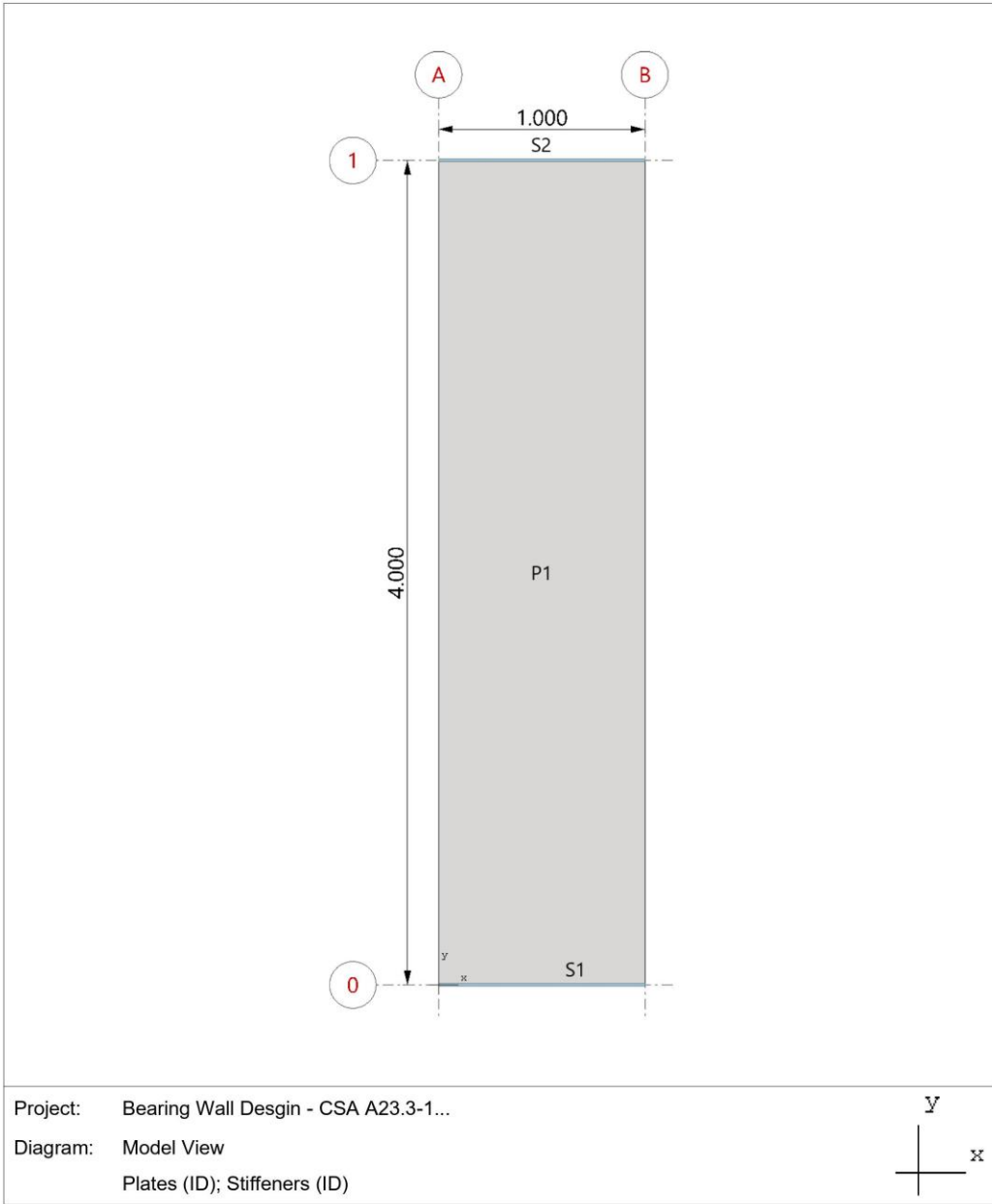

5.3. Restraints

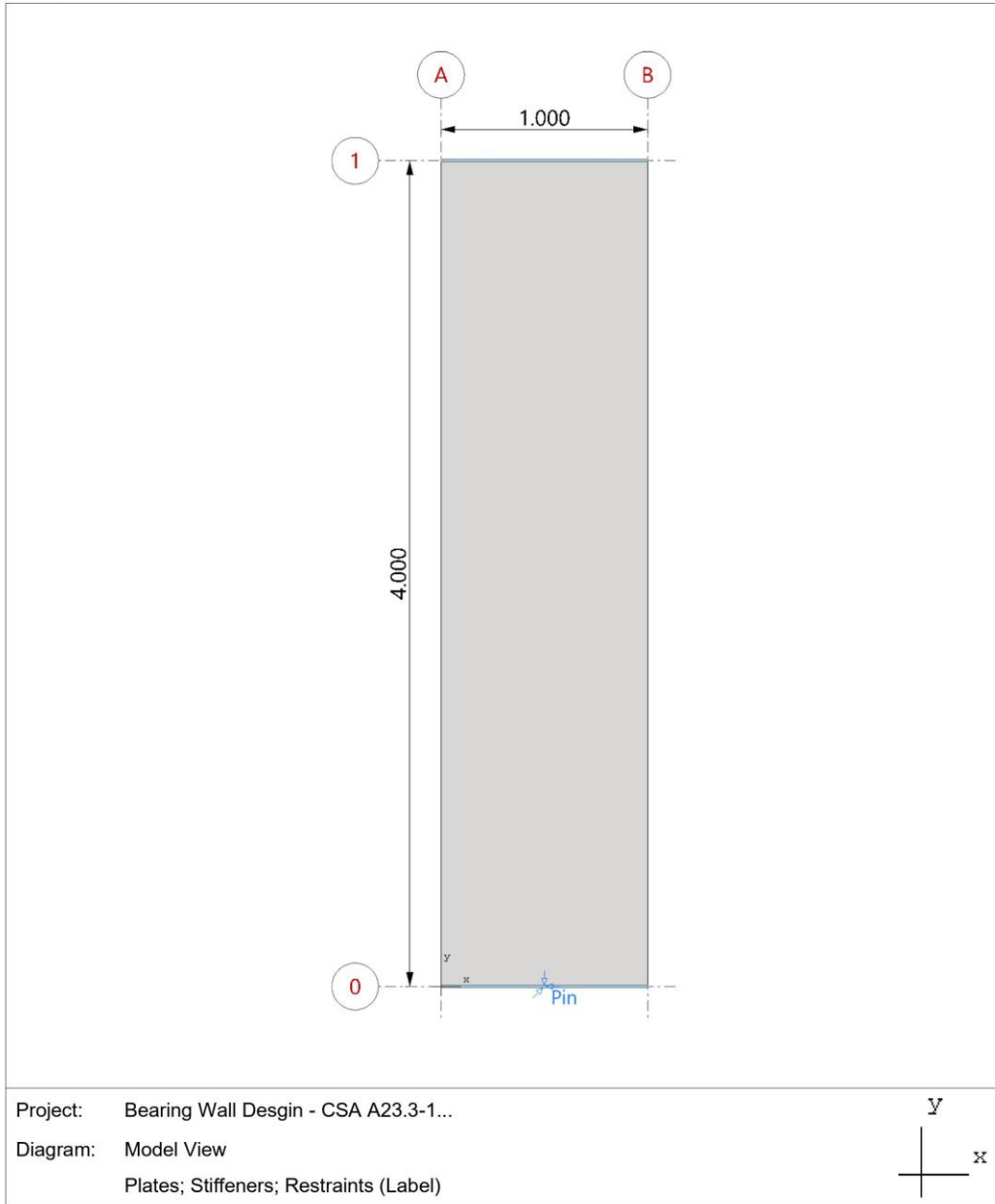

5.4. Loads - Case A - Dead

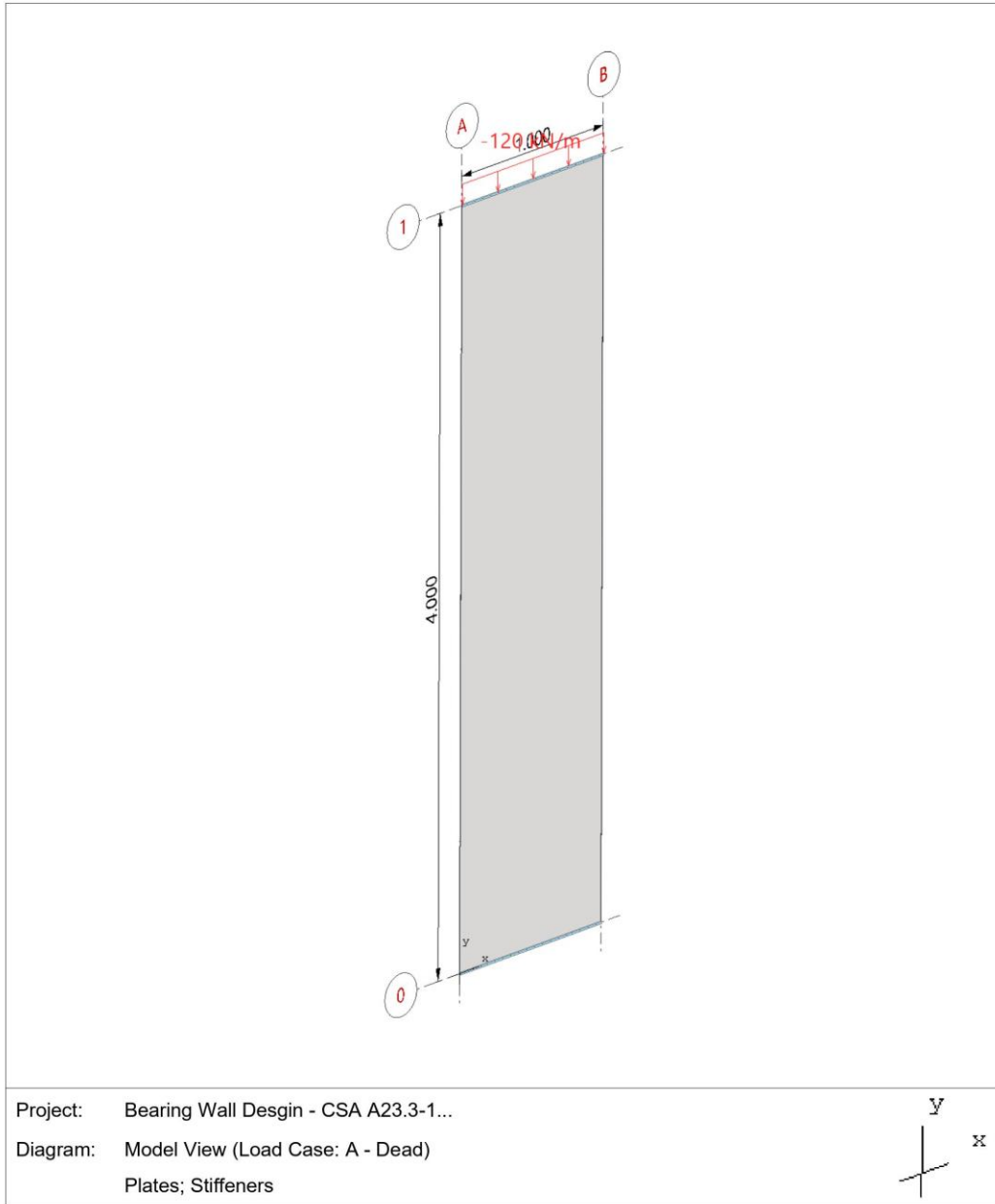

5.5. Loads - Case B - Live

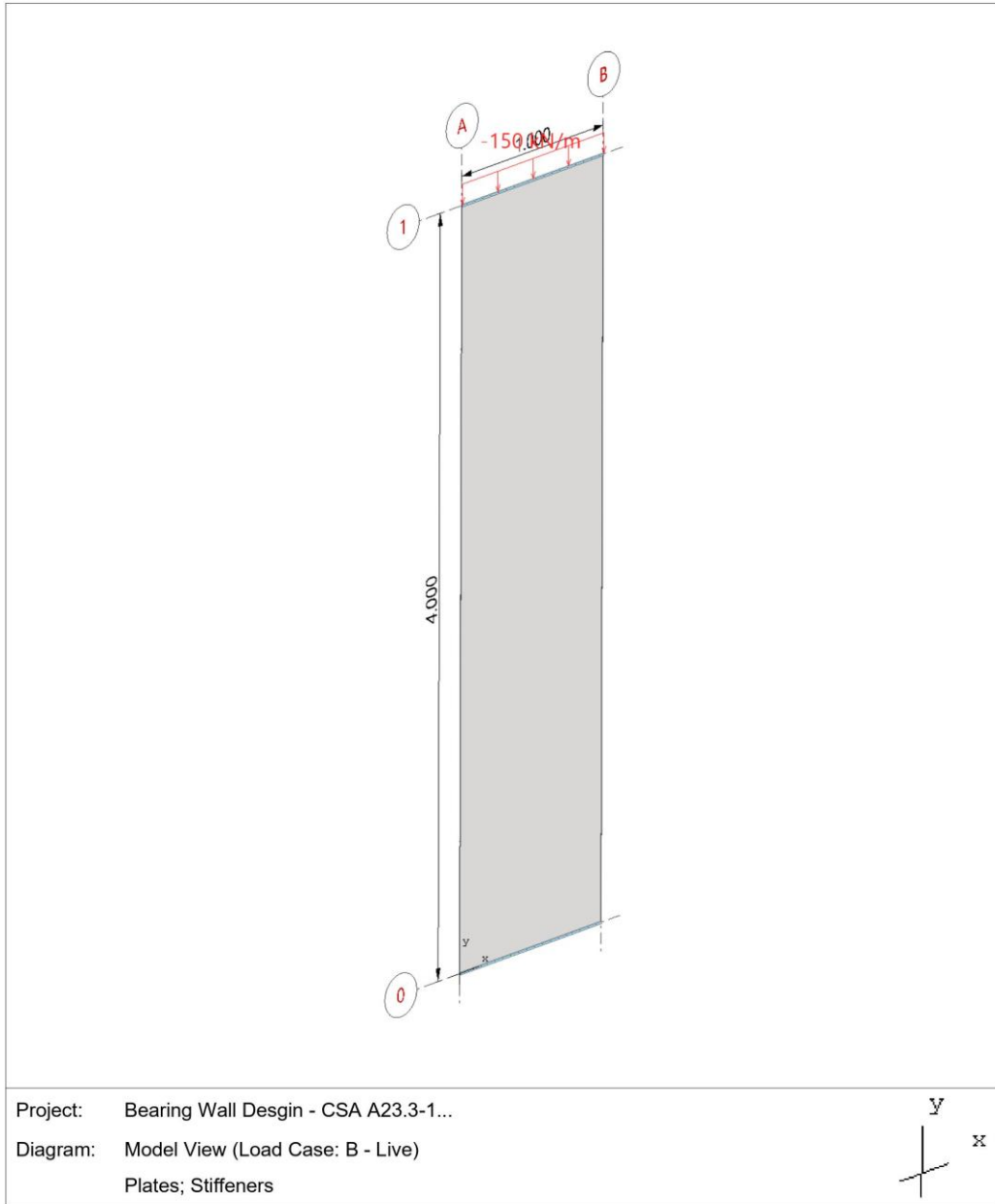

4. Design Results Comparison and Conclusions

Table 1 – Comparison of Precast Wall Panel Analysis and Design Results			
Solution	P_f (kN)	$A_{s,vertical}$ (mm ²)	$A_{s,horizontal}$ (mm ²)
Hand	375	525	700
Reference	375	525	700
spWall	375	525	700

The results of all the hand calculations and the reference used illustrated above are in precise agreement with the automated exact results obtained from the [spWall](#) program.

For investigation purposes, the [spWall](#) model was revised to apply a line load equals to the axial resistance of the concrete wall ($P_f = P_r = 2,821 \text{ kN/m}$). It was noticed that the minimum reinforcement still governs.

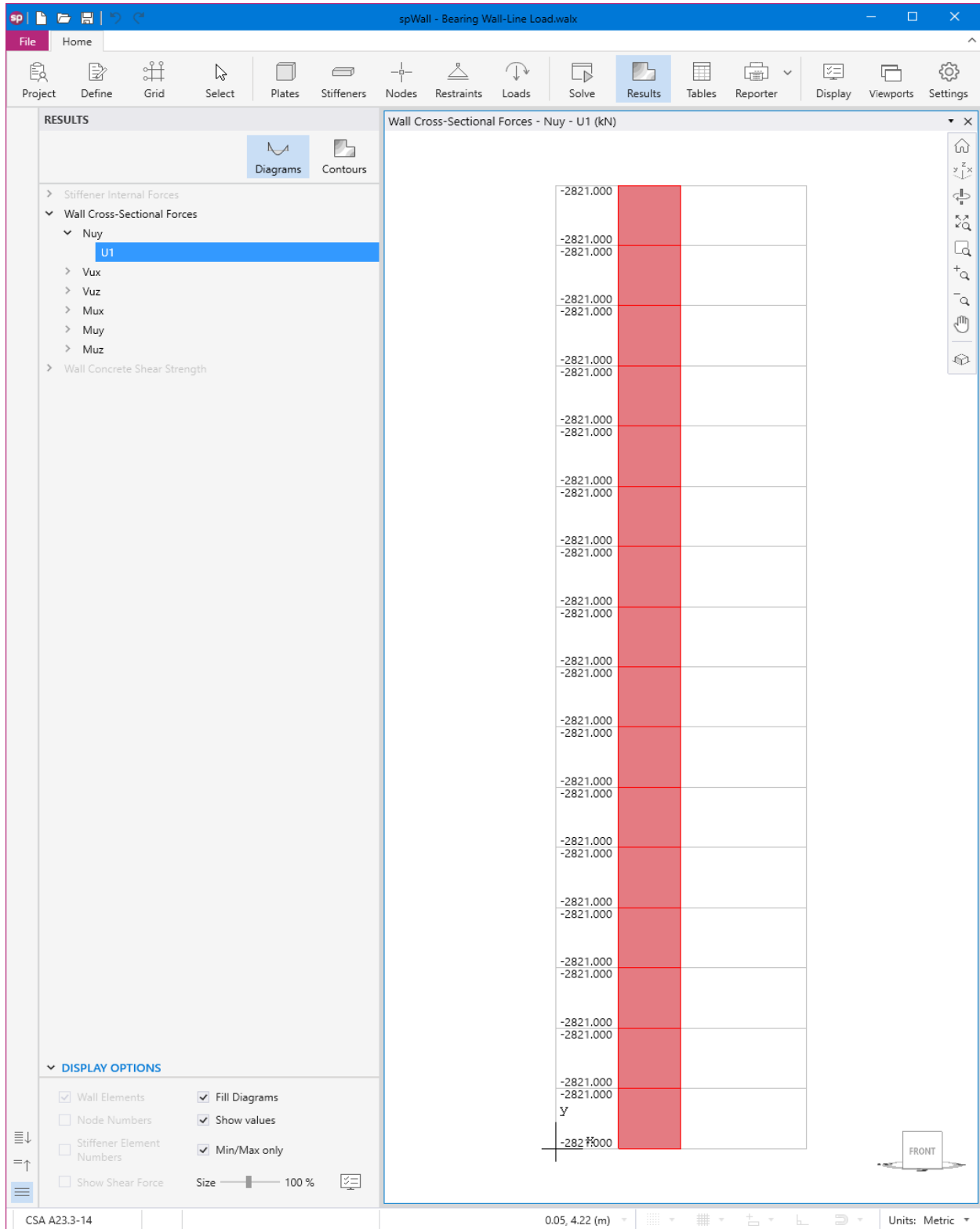

Figure 9 – Reinforced Concrete Bearing Wall Axial Load Diagram ($P_f = P_r = 2821 \text{ kN/m}$) (spWall)

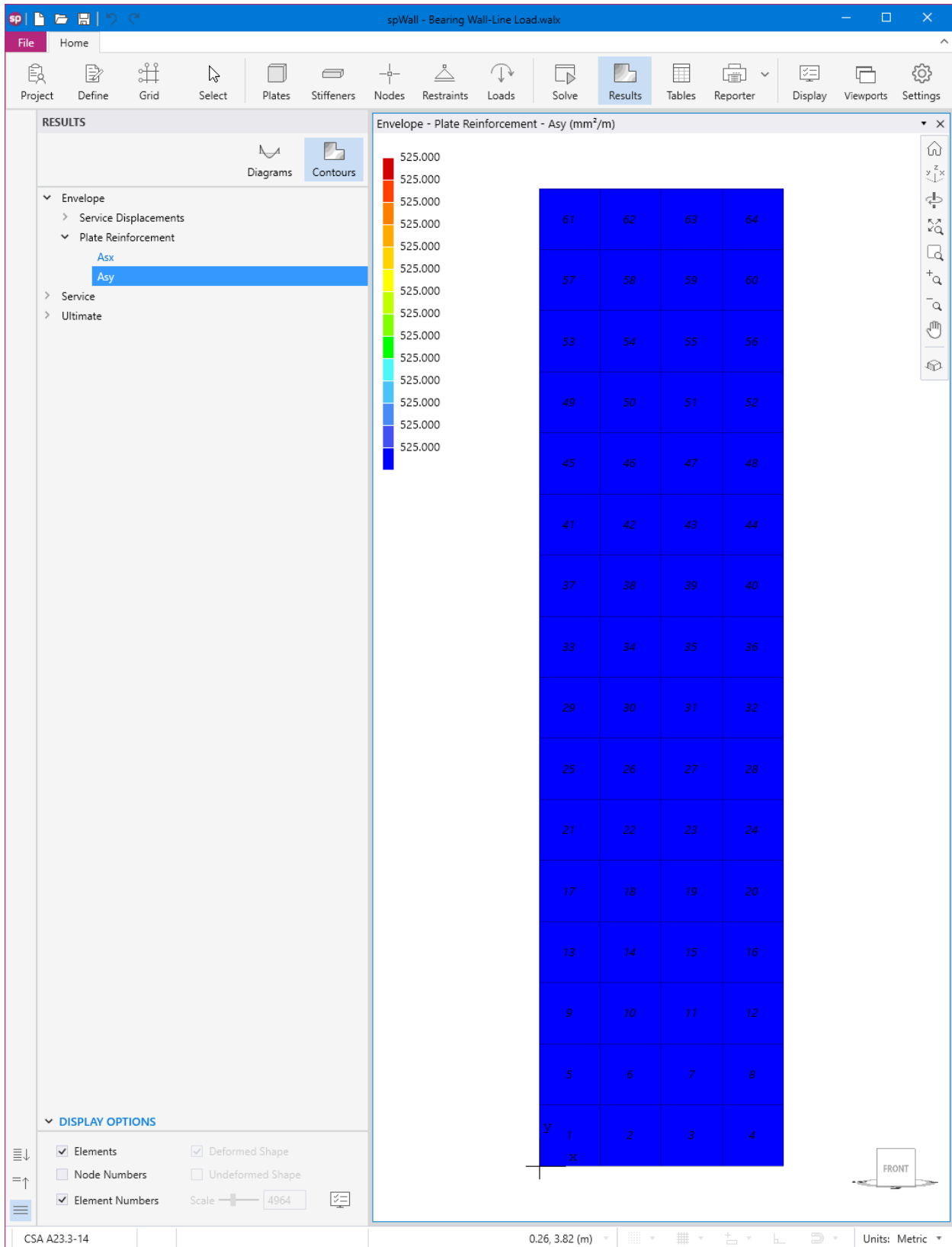

Figure 10 – Reinforced Concrete Bearing Wall Required Vertical Reinforcement ($P_f = P_r = 2821 \text{ kN/m}$) (spWall)

If required, the [spColumn](#) program can be used to analyze a model of this concrete wall to arrive at the complete interaction diagram including the maximum allowable compression capacity of this section.

