

Slender Concrete Column Design in Sway Frames - Moment Magnification Method (ACI 318-19)

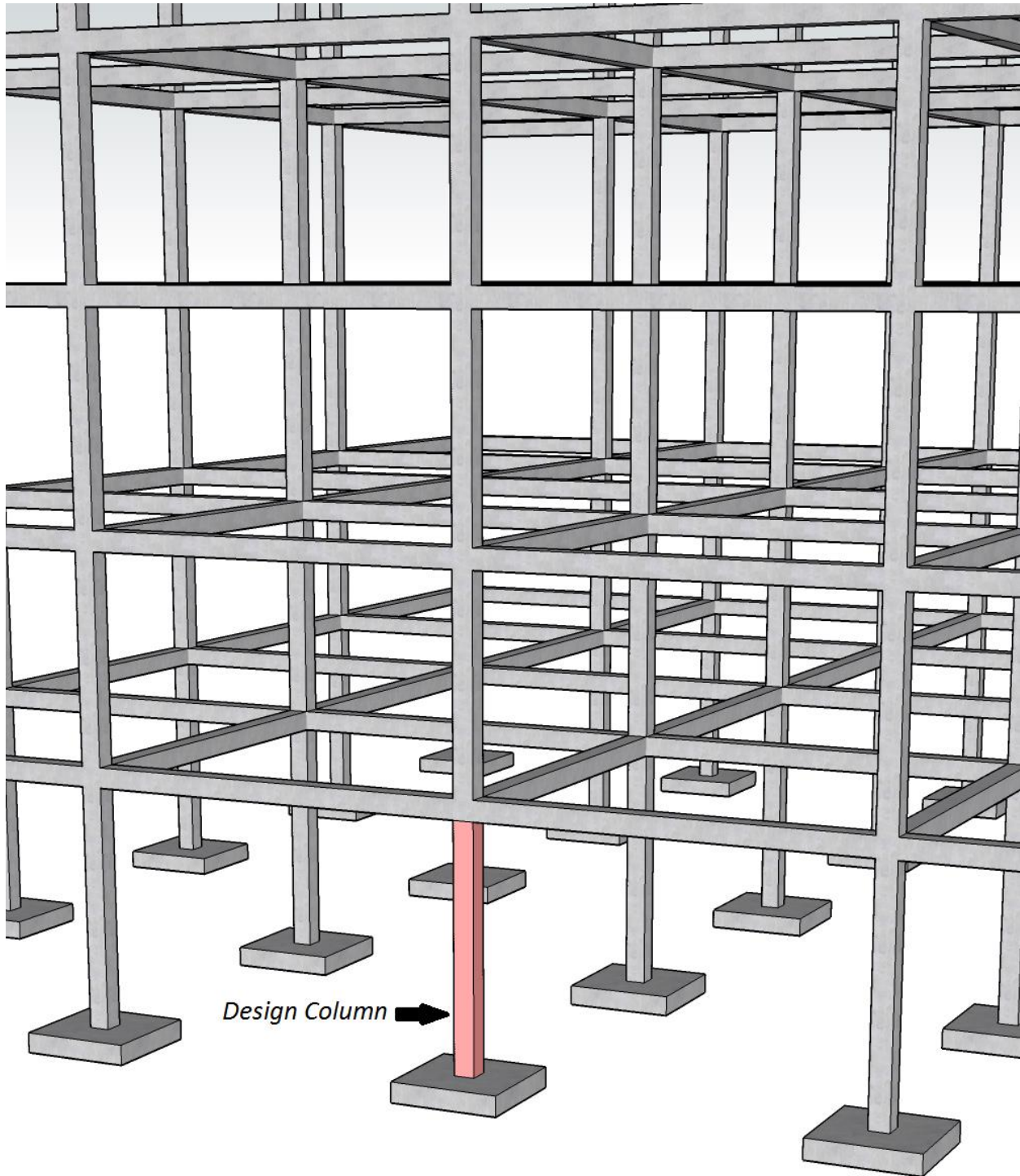

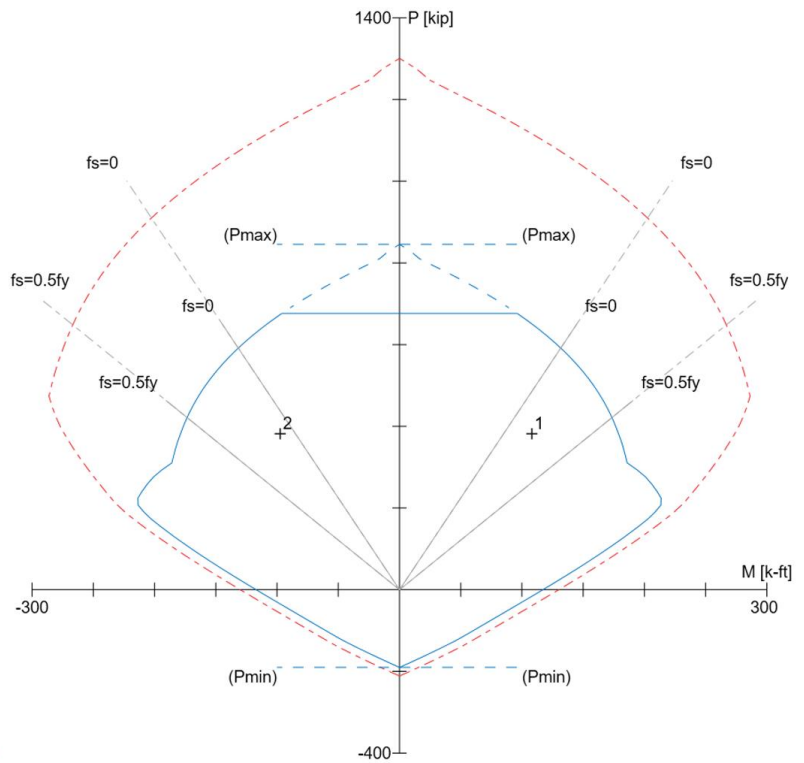
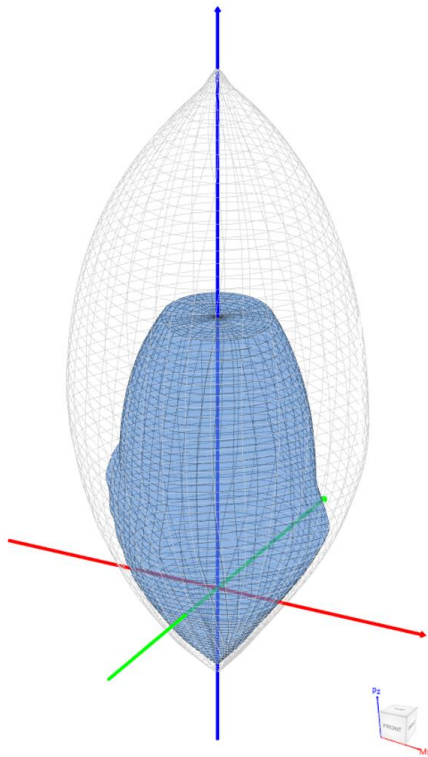
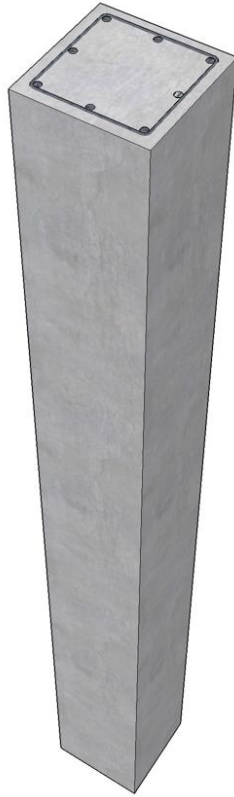

Slender Concrete Column Design in Sway Frames - Moment Magnification Method (ACI 318-19)

Evaluate slenderness effect for columns in a sway frame multistory reinforced concrete building by designing the first story exterior column. The clear height of the first story is 15 ft-6 in., and is 9 ft. for all of the other stories. Lateral load effects on the building are governed by wind forces. Compare the calculated results with the values presented in the Reference and with exact values from [spColumn](#) engineering software program from [StructurePoint](#).

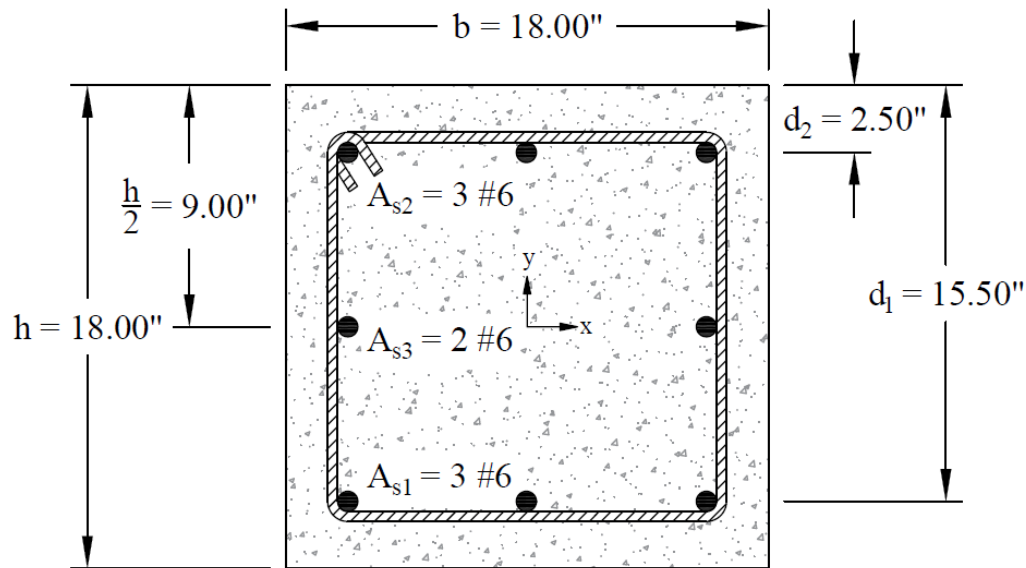

Figure 1 – Slender Reinforced Concrete Column Cross-Section

Contents

1. Factored Axial Loads and Bending Moments	2
1.1. Service loads	2
1.2. Load Combinations – Factored Loads	2
2. Slenderness Effects and Sway or Nonsway Frame Designation	3
3. Determine Slenderness Effects.....	4
4. Moment Magnification at Ends of Compression Member	5
4.1. Gravity Load Combination #2 (Gravity Loads Only)	5
4.2. Lateral Load Combination #6 (Gravity Plus Wind Loads)	6
5. Moment Magnification along Length of Compression Member	11
5.1. Gravity Load Combination #2 (Gravity Loads Only)	11
5.2. Lateral Load Combination #6 (Gravity Plus Wind Loads)	14
6. Column Design.....	18
6.1. c , a , and strains in the reinforcement	18
6.2. Forces in the concrete and steel.....	19
6.3. ϕP_n and ϕM_n	19
7. Column Interaction Diagram - spColumn Software.....	21
8. Summary and Comparison of Design Results	37
9. Conclusions & Observations	39

Code

Building Code Requirements for Structural Concrete (ACI 318-19) and Commentary (ACI 318R-19)

References

- Reinforced Concrete Mechanics and Design, 8th Edition, 2021, James Wight, Pearson, Example 12-3
- [spColumn Engineering Software Program Manual v10.00, STRUCTUREPOINT, 2021](#)
- “[Slenderness Effects for Concrete Columns in Sway Frame – Moment Magnification Method \(ACI 318-19\)](#)” Design Example, [STRUCTUREPOINT, 2022](#)
- “[Slenderness Effects for Columns in Non-Sway Frame – Moment Magnification Method \(ACI 318-19\)](#)” Design Example, [STRUCTUREPOINT, 2022](#)

Design Data

$f_c' = 4,000$ psi

$f_y = 60,000$ psi

Slab thickness = 6 in.

Exterior Columns = 18 in. x 18 in.

Interior Columns = 18 in. x 18 in.

Interior Beams = 18 in. x 30 in. x 30 ft

Exterior Beams = 18 in. x 30 in. x 32 ft

Floor superimposed dead load = 20 psf

Floor live load = 80 psf

Roof superimposed dead load = 25 psf

Roof live load = 30 psf

Wind loads computed according to ASCE 7-10

Total building loads in the first story from the reference:

ASCE 7-10 Reference	No.	Load Combination	$\sum P_u$, kip
2.3.2-1	1	1.4D	2,164
2.3.2-2	2	1.2D + 1.6L + 0.5L _r	2,293
2.3.2-3	3	1.2D + 0.5L + 1.6 L _r	2,074
	4	1.2D + 1.6L _r + 0.8W	1,962
	5	1.2D + 1.6L _r - 0.8W	1,931
2.3.2-4	6	1.2D + 0.5L + 0.5L _r + 1.0W	2,031
	7	1.2D + 0.5L + 0.5L _r - 1.0W	1,992
2.3.2-6	8	0.9D + 1.0W	1,411
	9	0.9D - 1.0W	1,372

1. Factored Axial Loads and Bending Moments

1.1. Service loads

Load Case	Axial Load, kip	Bending Moment, ft-kip	
		Top	Bottom
Dead, D	286.0	-36.2	-34.3
Live, L	48.9	-13.6	-12.9
Roof Live, L_r	9.98	0.0	0.0
Wind, W (N-S)	9.2	-53.8	-46.3

1.2. Load Combinations – Factored Loads

ASCE 7-10 (2.3.2)

ASCE 7-10 Reference	No.	Load Combination	Axial Load, kip	Bending Moment, ft-kip		$M_{Top,ns}$ ft-kip	$M_{Bottom,ns}$ ft-kip	$M_{Top,s}$ ft-kip	$M_{Bottom,s}$ ft-kip
				Top	Bottom				
2.3.2-1	1	1.4D	400.4	50.7	48.0	50.7	48.0	---	---
2.3.2-2	2	1.2D + 1.6L + 0.5 L_r	426.4	65.2	61.8	65.2	61.8	---	---
2.3.2-3	3	1.2D + 0.5L + 1.6 L_r	383.6	50.2	47.6	50.2	47.6	---	---
	4	1.2D + 1.6 L_r + 0.8W	366.5	86.5	78.2	43.4	41.2	43.0	37.0
	5	1.2D + 1.6 L_r - 0.8W	351.8	0.4	4.1	43.4	41.2	-43.0	-37.0
2.3.2-4	6	1.2D + 0.5L + 0.5 L_r + 1.0W	381.8	104.0	93.9	50.2	47.6	53.8	46.3
	7	1.2D + 0.5L + 0.5 L_r - 1.0W	363.4	-3.6	1.3	50.2	47.6	-53.8	-46.3
2.3.2-6	8	0.9D + 1.0W	266.6	86.4	77.2	32.6	30.9	53.8	46.3
	9	0.9D - 1.0W	248.2	-21.2	-15.4	32.6	30.9	-53.8	-46.3

2. Slenderness Effects and Sway or Nonsway Frame Designation

Columns and stories in structures are considered as nonsway frames if the increase in column end moments due to second-order effects does not exceed 5% of the first-order end moments, or the stability index for the story (Q) does not exceed 0.05. ACI 318-19 (6.6.4.3)

$\sum P_u$ is the total vertical load in the first story corresponding to the lateral loading case for which $\sum P_u$ is greatest (without the wind loads, which would cause compression in some columns and tension in others and thus would cancel out). ACI 318-19 (6.6.4.4.1 and R6.6.4.3)

V_{us} is the factored horizontal story shear in the first story corresponding to the wind loads, and Δ_o is the first-order relative deflection between the top and bottom of the first story due to V_{us} . ACI 318-19 (6.6.4.4.1 and R6.6.4.3)

From Table 1, load combination (2.3.2-2 No. 2) provides the greatest value of $\sum P_u$.

$$\sum P_u = 1.2 \times D + 1.6 \times L + 0.5 \times L_r = 2,293 \text{ kip} \quad \text{ASCE 7-10 (2.3.2-2)}$$

Since there is no lateral load in this load combination, the reference applied an arbitrary lateral load representing (V_{us}) at the top of the first story and calculated the resulting story lateral deflection (Δ_o).

$$V_{us} = 20 \text{ kip (given)}$$

$$\Delta_o = 0.16 \text{ in. (given)}$$

$$Q = \frac{\sum P_u \times \Delta_o}{V_{us} \times l_c} = \frac{2,293 \times 0.16}{20 \times (18 \times 12)} = 0.085 > 0.05 \quad \text{ACI 318-19 (Eq. 6.6.4.4.1)}$$

Thus, the frame at the first story level is considered sway.

3. Determine Slenderness Effects

$$I_{column} = 0.7 \times \frac{c^4}{12} = 0.7 \times \frac{18^4}{12} = 6,124 \text{ in.}^4$$

ACI 318-19 (Table 6.6.3.1.1(a))

$$E_c = 57,000 \times \sqrt{f'_c} = 57,000 \times \sqrt{4,000} = 3,605 \text{ ksi}$$

ACI 318-19 (19.2.2.1.b)

For the column below level 2:

$$\frac{E_c \times I_{column}}{l_c} = \frac{3,605 \times 6,124}{18 \times 12 - 20/2} = 110 \times 10^3 \text{ in.kip}$$

For the column above level 2:

$$\frac{E_c \times I_{column}}{l_c} = \frac{3,605 \times 6,124}{11.5} = 160 \times 10^3 \text{ in.kip}$$

For beams framing into the columns:

$$\frac{E_b \times I_{beam}}{l_b} = \frac{3,605 \times 14,175}{32 \times 12} = 133 \times 10^3 \text{ in.kip}$$

Where:

$$E_b = 57,000 \times \sqrt{f'_c} = 57,000 \times \sqrt{4,000} = 3,605 \text{ ksi}$$

ACI 318-19 (19.2.2.1.b)

$$I_{beam} = 0.35 \times \frac{b \times h^3}{12} = 0.35 \times \frac{18 \times 30^3}{12} = 14,175 \text{ in.}^4$$

ACI 318-19 (Table 6.6.3.1.1(a))

$$\Psi_A = \frac{\left(\sum \frac{EI}{l_c} \right)_{columns}}{\left(\sum \frac{EI}{l} \right)_{beams}} = \frac{110 + 160}{133} = 2.027$$

ACI 318-19 (Figure R6.2.5.1)

$$\Psi_B = 0.0 \text{ (Column considered fixed at the base)}$$

ACI 318-19 (Figure R6.2.5.1)

Using Figure R6.2.5.1 from ACI 318-19 $\rightarrow k = 1.282$ as shown in the figure below for the exterior column.

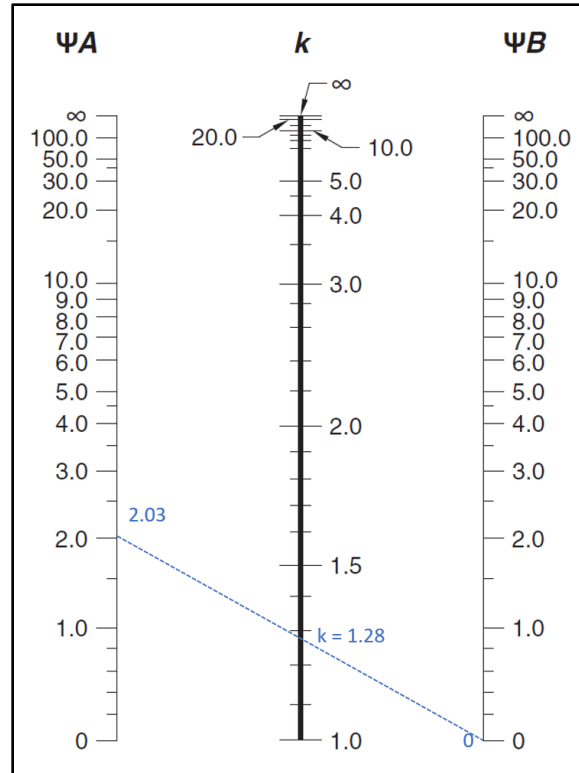

Figure 2 – Effective Length Factor (k) for Exterior Column (Sway Frame)

$$\frac{k \times l_u}{r} = \frac{1.282 \times 15.5}{5.196} = 45.90 > 22 \rightarrow \text{Consider Slenderness}$$

ACI 318-19 (6.2.5.1a)

Where:

$$r = \text{radius of gyration} = (a) \sqrt{\frac{I_g}{A_g}} \quad \text{or} \quad (b) 0.3 \times c_1$$

ACI 318-19 (6.2.5.2)

$$r = \sqrt{\frac{I_g}{A_g}} = \sqrt{\frac{18^4 / 12}{18^2}} = 5.196 \text{ in.}$$

4. Moment Magnification at Ends of Compression Member

A detailed calculation for load combinations 2 and 6 is shown below to illustrate the slender column moment magnification procedure. Table 4 summarizes the magnified moment computations for the exterior columns.

4.1. Gravity Load Combination #2 (Gravity Loads Only)

$$M_2 = M_{2ns} + \delta_s M_{2s}$$

ACI 318-19 (6.6.4.6.1b)

Where:

$$M_{Top_s} = M_{Bottom_s} = M_{2_s} = 0 \text{ ft.kip}$$

$$\therefore M_2 = M_{2ns}$$

$$M_{Top_2^{nd}} = M_{Top,ns} = 65.2 \text{ ft.kip}$$

$$M_{Bottom_2^{nd}} = M_{Bottom,ns} = 61.8 \text{ ft.kip}$$

$$M_{2_2^{nd}} = \max(M_{Top_2^{nd}}, M_{Bottom_2^{nd}}) = M_{Top_2^{nd}} = 65.2 \text{ ft.kip} \rightarrow M_{1_1^{st}} = M_{Top_1^{st}} = 65.2 \text{ ft.kip}$$

$$M_{1_2^{nd}} = \min(M_{Top_2^{nd}}, M_{Bottom_2^{nd}}) = M_{Bottom_2^{nd}} = 61.8 \text{ ft.kip} \rightarrow M_{1_1^{st}} = M_{Bottom_1^{st}} = 61.8 \text{ ft.kip}$$

$$P_u = 426.4 \text{ kip}$$

4.2. Lateral Load Combination #6 (Gravity Plus Wind Loads)

$$M_2 = M_{2ns} + \delta_s M_{2s}$$

ACI 318-19 (6.6.4.6.1b)

Where:

$$\delta_s = \text{moment magnifier} = \left\{ \begin{array}{l} \text{(a) } \frac{1}{1-Q} \\ \text{(b) } \frac{1}{1 - \frac{\sum P_u}{0.75 \sum P_c}} \\ \text{(c) Second-order elastic analysis} \end{array} \right\}$$

ACI 318-19 (6.6.4.6.2)

There are three options for calculating δ_s . ACI 318-19 (6.6.4.6.2(b)) will be used since it does not require a detailed structural analysis model results to proceed and is also used by the solver engine in [spColumn](#).

$\sum P_u$ is the summation of all the factored vertical loads in the first story, and $\sum P_c$ is the summation of the critical buckling load for all sway-resisting columns in the first story.

$$P_c = \frac{\pi^2 (EI)_{eff}}{(kl_u)^2}$$

ACI 318-19 (6.6.4.4.2)

Where:

$$(EI)_{eff} = \left\{ \begin{array}{l} \text{(a) } \frac{0.4E_c I_g}{1 + \beta_{ds}} \\ \text{(b) } \frac{0.2E_c I_g + E_s I_{se}}{1 + \beta_{ds}} \\ \text{(c) } \frac{E_c I}{1 + \beta_{ds}} \end{array} \right\}$$

ACI 318-19 (6.6.4.4.4)

There are three options for calculating the effective flexural stiffness of slender concrete columns $(EI)_{eff}$. The second equation provides accurate representation of the reinforcement in the section and will be used in this example and

is also used by the solver in [spColumn](#). Further comparison of the available options is provided in “[Effective Flexural Stiffness for Critical Buckling Load of Concrete Columns](#)” technical note.

$$I_{column} = \frac{c^4}{12} = \frac{18^4}{12} = 8,748 \text{ in.}^4 \quad \text{ACI 318-19 (Table 6.6.3.1.1(a))}$$

$$E_c = 57,000 \times \sqrt{f'_c} = 57,000 \times \sqrt{4000} = 3,605 \text{ ksi} \quad \text{ACI 318-19 (19.2.2.1.b)}$$

β_{ds} is the ratio of maximum factored sustained shear within a story to the maximum factored shear in that story associated with the same load combination. The maximum factored sustained shear in this example is equal to zero leading to $\beta_{ds} = 0$. ACI 318-19 (6.6.3.1.1)

For exterior columns with one beam framing into them in the direction of analysis (8 columns):

With 8-#6 reinforcement equally distributed on all sides $I_{se} = 111.5 \text{ in.}^4$ (Ref. uses approximate value of 150 in.^4 in lieu of exact value calculated by [spColumn](#)).

$$(EI)_{eff} = \frac{0.2E_c I_g + E_s I_{se}}{1 + \beta_{ds}} \quad \text{ACI 318-19 (6.6.4.4.4(b))}$$

$$(EI)_{eff} = \frac{0.2 \times 3,605 \times 8,748 + 29,000 \times 111.5}{1 + 0} = 9.5 \times 10^6 \text{ kip-in.}^2$$

$k = 1.282$ (calculated previously).

$$P_{c1} = \frac{\pi^2 \times 9.5 \times 10^6}{(1.282 \times 15.5 \times 12)^2} = 1,655.59 \text{ kip}$$

For exterior columns with two beams framing into them in the direction of analysis (8 columns):

$$\Psi_A = \frac{\left(\sum \frac{EI}{l_c} \right)_{columns}}{\left(\sum \frac{EI}{l} \right)_{beams}} = \frac{110 + 160}{133 + 142} = 0.981 \quad \text{ACI 318-19 (Figure R6.2.5.1)}$$

$$\Psi_B = 0.0 \text{ (Column essentially fixed at base)} \quad \text{ACI 318-19 (Figure R6.2.5.1)}$$

Using Figure R6.2.5.1 from ACI 318-19 $\rightarrow k = 1.154$ as shown in the figure below for the exterior columns with two beams framing into them in the directions of analysis.

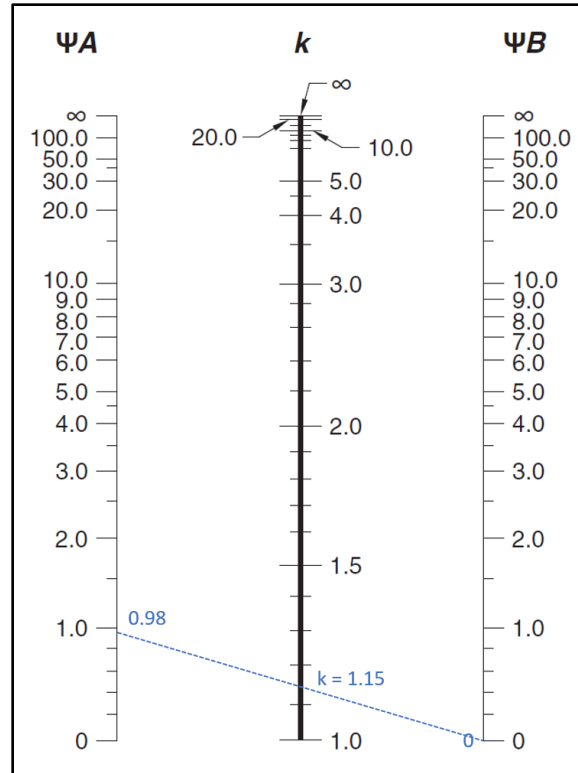

Figure 3 – Effective Length Factor (k) for Exterior Columns with Two Beams Framing into them in the Direction of Analysis

$$P_{c2} = \frac{\pi^2 \times 9.5 \times 10^6}{(1.154 \times 15.5 \times 12)^2} = 2043,84 \text{ kip}$$

For interior columns (8 columns):

$$\Psi_A = \frac{\left(\sum \frac{EI}{l_c} \right)_{columns}}{\left(\sum \frac{EI}{l} \right)_{beams}} = \frac{110+160}{133+142} = 0.981$$

ACI 318-19 (Figure R6.2.5.1)

$$\Psi_B = 0.0 \text{ (Column essentially fixed at base)}$$

ACI 318-19 (Figure R6.2.5.1)

Using Figure R6.2.5.1 from ACI 318-19 $\rightarrow k = 1.154$ as shown in the figure below for the interior columns.

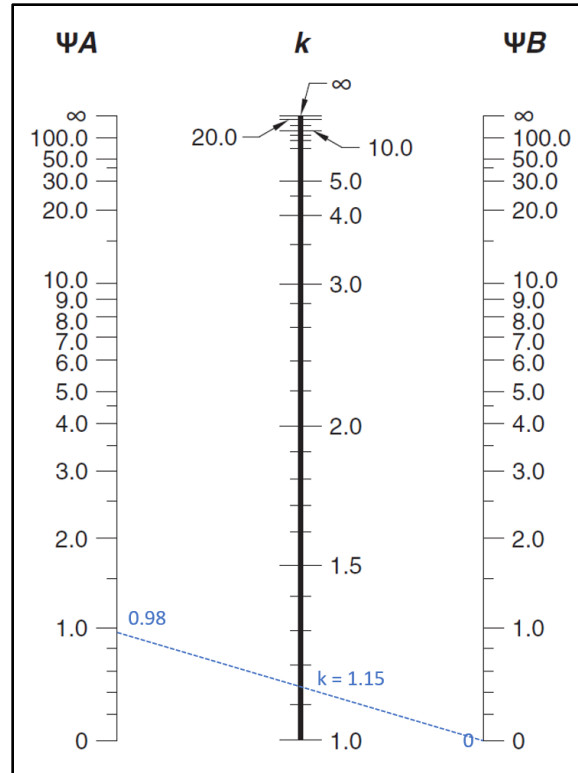

Figure 4 – Effective Length Factor (k) Calculations for Interior Columns

With 8-#8 reinforcement equally distributed on all sides $I_{se} = 192.6 \text{ in.}^4$

$$(EI)_{eff} = \frac{0.2E_c I_g + E_s I_{se}}{1 + \beta_{ds}}$$

ACI 318-19 (6.6.4.4.4(b))

$$(EI)_{eff} = \frac{0.2 \times 3,605 \times 8,748 + 29,000 \times 192.6}{1 + 0} = 11.9 \times 10^6 \text{ kip-in.}^2$$

$$P_{c3} = \frac{\pi^2 \times 11.9 \times 10^6}{(1.154 \times 15.5 \times 12)^2} = 2,547.67 \text{ kip}$$

$$\Sigma P_c = n_1 \times P_{c1} + n_2 \times P_{c2} + n_3 \times P_{c3}$$

$$\Sigma P_c = 8 \times 1,655.59 + 8 \times 2,043.84 + 8 \times 2,547.67 = 49,976.83 \text{ kip}$$

$$\Sigma P_u = 2,031 \text{ kip (Table 1)}$$

$$\delta_s = \frac{1}{1 - \frac{\Sigma P_u}{0.75 \times \Sigma P_c}}$$

ACI 318-19 (6.6.4.6.2(b))

$$\delta_s = \frac{1}{1 - \frac{2,031}{0.75 \times 49,976.83}} = 1.057$$

$$\delta_s M_{Top,s} = 1.057 \times 53.8 = 56.88 \text{ ft.kip}$$

$$M_{Top_2^{nd}} = M_{Top,ns} + \delta_s M_{Top,s} = 50.24 + 56.88 = 107.12 \text{ ft.kip} \quad \text{ACI 318-19 (6.6.4.6.1)}$$

$$\delta_s M_{Bottom,s} = 1.057 \times 46.30 = 48.95 \text{ ft.kip}$$

$$M_{Bottom_2^{nd}} = M_{Bottom,ns} + \delta_s M_{Bottom,s} = 47.61 + 48.95 = 96.56 \text{ ft.kip} \quad \text{ACI 318-19 (6.6.4.6.1)}$$

$$M_{2_2^{nd}} = \max(M_{Top_2^{nd}}, M_{Bottom_2^{nd}}) = M_{Top_2^{nd}} = 107.12 \text{ ft.kip} \rightarrow M_{2_1^{st}} = M_{Top_1^{st}} = 104.04 \text{ ft.kip}$$

$$M_{1_2^{nd}} = \min(M_{Top_2^{nd}}, M_{Bottom_2^{nd}}) = M_{Bottom_2^{nd}} = 96.56 \text{ ft.kip} \rightarrow M_{1_1^{st}} = M_{Bottom_1^{st}} = 93.91 \text{ ft.kip}$$

$$P_u = 381.8 \text{ kip}$$

A summary of the moment magnification factors and magnified moments for the exterior column for all load combinations using both equation options ACI 318-19 (6.6.4.6.2(a)) and (6.6.4.6.2(b)) to calculate δ_s is provided in the table below for illustration and comparison purposes. Note: The designation of M_1 and M_2 is made based on the second-order (magnified) moments and not based on the first-order (unmagnified) moments.

Table 4 - Factored Axial loads and Magnified Moments at the Ends of Exterior Column								
No.	Load Combination	Axial Load,	Using ACI 6.6.4.6.2(a)			Using ACI 6.6.4.6.2(b)		
		Kip	δ_s	M_1 , ft-kip	M_2 , ft-kip	δ_s	M_1 , ft-kip	M_2 , ft-kip
1	1.4D	400.4	*	*	*	1.06	48.0	50.7
2	1.2D + 1.6L + 0.5L _r	426.4	1.09	61.8	65.2	1.07	61.8	65.2
3	1.2D + 0.5L + 1.6 L _r	383.6	*	*	*	1.06	47.6	50.2
4	1.2D + 1.6L _r + 0.8W	366.5	*	*	*	1.06	80.3	88.9
5	1.2D + 1.6L _r - 0.8W	351.8	*	*	*	1.05	-1.9	2.1
6	1.2D + 0.5L + 0.5L _r + 1.0W	381.8	1.08	97.7	108.4	1.06	96.6	107.1
7	1.2D + 0.5L + 0.5L _r - 1.0W	363.4	*	*	*	1.06	-1.3	-6.6
8	0.9D + 1.0W	266.6	*	*	*	1.04	78.9	88.5
9	0.9D - 1.0W	248.2	*	*	*	1.04	-17.2	-23.3

* Not covered by the reference

5. Moment Magnification along Length of Compression Member

In sway frames, second-order effects shall be considered along the length of columns. It shall be permitted to account for these effects using ACI 318-19 (6.6.4.5) (Nonsway frame procedure), where C_m is calculated using M_1 and M_2 from ACI 318-19 (6.6.4.6.1) as follows: ACI 318-19 (6.6.4.6.4)

$$M_{c2} = \delta M_2 \quad \text{ACI 318-19 (6.6.4.5.1)}$$

Where:

M_2 = the second-order factored moment.

$$\delta = \text{magnification factor} = \frac{C_m}{1 - \frac{P_u}{0.75P_c}} \geq 1.0 \quad \text{ACI 318-19 (6.6.4.5.2)}$$

$$P_c = \frac{\pi^2 (EI)_{eff}}{(kl_u)^2} \quad \text{ACI 318-19 (6.6.4.4.2)}$$

Where:

$$(EI)_{eff} = \left\{ \begin{array}{l} \text{(a) } \frac{0.4E_c I_g}{1 + \beta_{dns}} \\ \text{(b) } \frac{0.2E_c I_g + E_s I_{se}}{1 + \beta_{dns}} \\ \text{(c) } \frac{E_c I}{1 + \beta_{dns}} \end{array} \right\} \quad \text{ACI 318-19 (6.6.4.4.4)}$$

There are three options for calculating the effective flexural stiffness of slender concrete columns $(EI)_{eff}$. The second equation provides accurate representation of the reinforcement in the section and will be used in this example and is also used by the solver in [spColumn](#). Further comparison of the available options is provided in “[Effective Flexural Stiffness for Critical Buckling Load of Concrete Columns](#)” technical note.

5.1. Gravity Load Combination #2 (Gravity Loads Only)

$$I_{column} = 0.70 \times \frac{c^4}{12} = 0.70 \times \frac{18^4}{12} = 6,124 \text{ in.}^4 \quad \text{ACI 318-19 (Table 6.6.3.1.1(a))}$$

$$E_c = 57,000 \times \sqrt{f'_c} = 57,000 \times \sqrt{4000} = 3,605 \text{ ksi} \quad \text{ACI 318-19 (19.2.2.1.b)}$$

β_{dns} is the ratio of maximum factored sustained axial load to maximum factored axial load associated with the same load combination. ACI 318-19 (6.6.4.4.4)

$$P_{u,sustained} = 1.2 \times 286 = 343.20 \text{ kip}$$

$$P_u = 1.2 \times 286 + 1.6 \times 48.9 + 0.5 \times 9.98 = 426.43 \text{ kip}$$

$$\beta_{dns} = \frac{P_{u,sustained}}{P_u} = \frac{343.20}{426.43} = 0.805 < 1.00 \rightarrow \therefore \beta_{dns} = 0.805$$

$$\Psi_A = \frac{\left(\sum \frac{EI}{l_c} \right)_{columns}}{\left(\sum \frac{EI}{l} \right)_{beams}} = \frac{110 + 160}{133} = 2.027 \text{ (Calculated previously)}$$

ACI 318-19 (Figure R6.2.5.1)

$$\Psi_B = 0.0 \text{ (Column essentially fixed at base)}$$

ACI 318-19 (Figure R6.2.5.1)

Using Figure R6.2.5.1(a) from ACI 318-19 $\rightarrow k = 0.656$ as shown in the figure below for the exterior column.

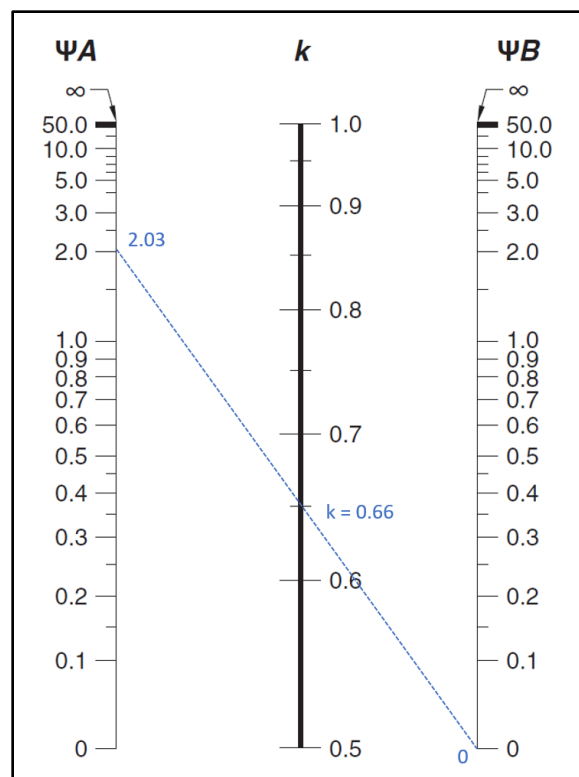

Figure 5 – Effective Length Factor (k) Calculations for Exterior Column (Nonsway)

With 8-#6 reinforcement equally distributed on all sides $I_{se} = 111.5 \text{ in.}^4$ (Ref. uses approximate value of 150 in.^4 in lieu of exact value calculated by [spColumn](#)).

$$(EI)_{eff} = \frac{0.2E_c I_g + E_s I_{se}}{1 + \beta_{dns}} \quad \text{ACI 318-19 (6.6.4.4.4(b))}$$

$$(EI)_{eff} = \frac{0.2 \times 3,605 \times 6,124 + 29,000 \times 111.5}{1 + 0.805} = 5.3 \times 10^6 \text{ kip-in.}^2$$

$$P_c = \frac{\pi^2 \times 5.3 \times 10^6}{(0.656 \times 15.5 \times 12)^2} = 3,504.43 \text{ kip}$$

$$P_u = 1.2 \times 286 + 1.6 \times 48.9 + 0.5 \times 9.98 = 426.43 \text{ kip}$$

ASCE 7-10 (2.3.2-2)

$$C_m = 0.6 + 0.4 \frac{M_1}{M_2}$$

ACI 318-19 (6.6.4.5.3a)

$$M_2 = M_{2_2nd} = 65.2 \text{ ft.kip (as concluded from section 4)}$$

ACI 318-19 (6.6.4.6.4)

$$M_1 = M_{1_2nd} = 61.8 \text{ ft.kip (as concluded from section 4)}$$

ACI 318-19 (6.6.4.6.4)

Since the column is bent in double curvature, M_1/M_2 is positive.

ACI 318-19 (6.6.4.5.3)

$$C_m = 0.6 - 0.4 \left(\frac{61.8}{65.2} \right) = 0.221$$

$$\delta = \frac{C_m}{1 - \frac{P_u}{0.75P_c}} \geq 1.0$$

ACI 318-19 (6.6.4.5.2)

$$\delta = \frac{0.221}{1 - \frac{426.43}{0.75 \times 3,504.43}} = 0.264 < 1.00 \rightarrow \delta = 1.00$$

$$M_{\min} = P_u (0.6 + 0.03h)$$

ACI 318-19 (6.6.4.5.4)

Where $P_u = 426.4$ kip, and h = the section dimension in the direction being considered = 18 in.

$$M_{\min} = 426.43 \left(\frac{0.6 + 0.03 \times 18}{12} \right) = 40.51 \text{ ft.kip}$$

$$M_1 = 61.80 \text{ ft.kip} > M_{\min} = 40.51 \text{ ft.kip} \rightarrow M_1 = 61.80 \text{ ft.kip}$$

ACI 318-19 (6.6.4.5.4)

$$M_{c1} = \delta M_1$$

ACI 318-19 (6.6.4.5.1)

$$M_{c1} = 1.00 \times 61.80 = 61.80 \text{ ft.kip}$$

$$M_2 = 65.20 \text{ ft.kip} > M_{2,\min} = 40.51 \text{ ft.kip} \rightarrow M_2 = 65.20 \text{ ft.kip}$$

ACI 318-19 (6.6.4.5.4)

$$M_{c2} = \delta M_2$$

ACI 318-19 (6.6.4.5.1)

$$M_{c2} = 1.00 \times 65.20 = 65.20 \text{ ft.kip}$$

M_{c1} and M_{c2} will be considered separately to ensure proper comparison of resulting magnified moments against negative and positive moment capacities of unsymmetrical sections as can be seen in the following figure.

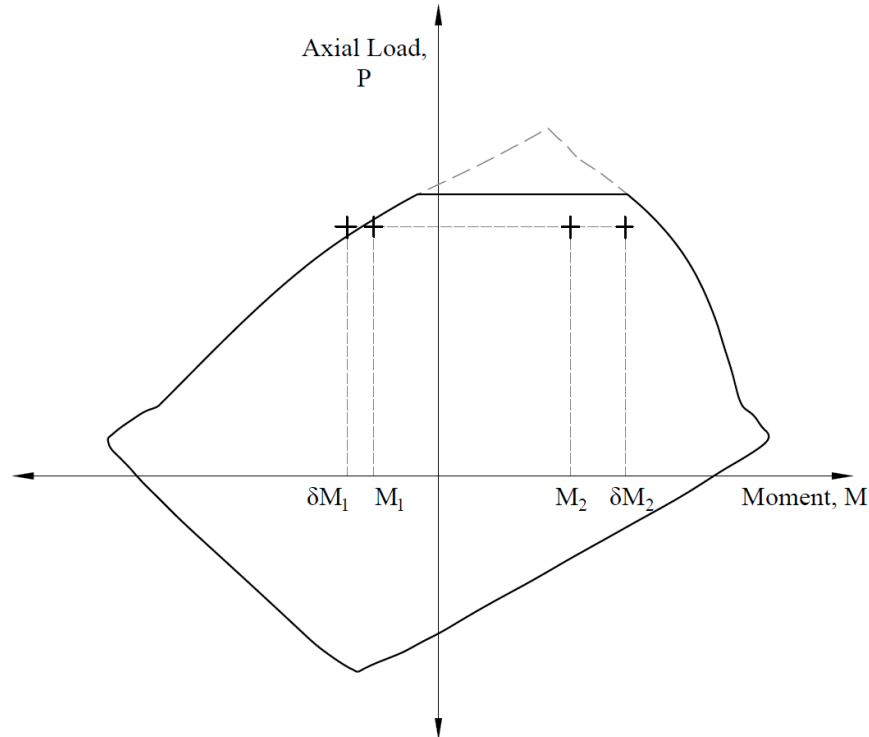

Figure 6 – Column Interaction Diagram for Unsymmetrical Section

5.2. Lateral Load Combination #6 (Gravity Plus Wind Loads)

$$I_{column} = \frac{c^4}{12} = \frac{18^4}{12} = 6,124 \text{ in.}^4$$

ACI 318-19 (Table 6.6.3.1.1(a))

$$E_c = 57,000 \times \sqrt{f'_c} = 57,000 \times \sqrt{4000} = 3,605 \text{ ksi}$$

ACI 318-19 (19.2.2.1.b)

β_{dns} is the ratio of maximum factored sustained axial load to maximum factored axial load associated with the same load combination.

ACI 318-19 (6.6.4.4.4)

$$P_{u,sustained} = 1.2 \times 286 = 343.20 \text{ kip}$$

$$P_u = 1.2 \times 286 + 0.5 \times 48.9 + 0.5 \times 9.98 + 1.6 \times 9.2 = 381.84 \text{ kip}$$

$$\beta_{dns} = \frac{P_{u,sustained}}{P_u} = \frac{343.20}{381.84} = 0.899 < 1.00 \rightarrow \therefore \beta_{dns} = 0.899$$

$$\Psi_A = \frac{\left(\sum \frac{EI}{l_c} \right)_{columns}}{\left(\sum \frac{EI}{l} \right)_{beams}} = \frac{110 + 160}{133} = 2.027 \text{ (Calculated previously)}$$

ACI 318-19 (Figure R6.2.5.1)

$$\Psi_B = 0.0 \text{ (Column essentially fixed at base)}$$

ACI 318-19 (Figure R6.2.5.1)

Using Figure R6.2.5.1(a) from ACI 318-19 $\rightarrow k = 0.656$

With 8-#6 reinforcement equally distributed on all sides $I_{se} = 111.5 \text{ in.}^4$ (Ref. uses approximate value of 150 in.^4 in lieu of exact value calculated by [spColumn](#)).

$$(EI)_{eff} = \frac{0.2E_c I_g + E_s I_{se}}{1 + \beta_{dns}} \quad \text{ACI 318-19 (6.6.4.4(b))}$$

$$(EI)_{eff} = \frac{0.2 \times 3,605 \times 6,124 + 29,000 \times 111.5}{1 + 0.899} = 5.02 \times 10^6 \text{ kip-in.}^2$$

$$P_c = \frac{\pi^2 \times 5.02 \times 10^6}{(0.899 \times 15.5 \times 12)^2} = 3,330.97 \text{ kip}$$

$$P_u = 1.2 \times 286 + 0.5 \times 48.9 + 0.5 \times 9.98 + 1.6 \times 9.2 = 381.84 \text{ kip} \quad \text{ASCE 7-10 (2.3.2-4)}$$

$$C_m = 0.6 + 0.4 \frac{M_1}{M_2} \quad \text{ACI 318-19 (6.6.4.5.3a)}$$

$$M_2 = M_{2_2nd} = 107.12 \text{ ft.kip (as concluded from section 4)} \quad \text{ACI 318-19 (6.6.4.6.4)}$$

$$M_1 = M_{1_2nd} = 96.56 \text{ ft.kip (as concluded from section 4)} \quad \text{ACI 318-19 (6.6.4.6.4)}$$

Since the column is bent in double curvature, M_1/M_2 is positive. ACI 318-19 (6.6.4.5.3)

$$C_m = 0.6 - 0.4 \left(\frac{107.1}{95.6} \right) = 0.239$$

$$\delta = \frac{C_m}{1 - \frac{P_u}{0.75P_c}} \geq 1.0 \quad \text{ACI 318-19 (6.6.4.5.2)}$$

$$\delta = \frac{0.239}{1 - \frac{381.84}{0.75 \times 3,330.97}} = 0.283 < 1.00 \rightarrow \delta = 1.00$$

$$M_{min} = P_u (0.6 + 0.03h) \quad \text{ACI 318-19 (6.6.4.5.4)}$$

Where $P_u = 381.8 \text{ kip}$, and $h =$ the section dimension in the direction being considered = 18 in.

$$M_{min} = 381.84 \left(\frac{0.6 + 0.03 \times 18}{12} \right) = 36.27 \text{ ft.kip}$$

$$M_1 = 96.56 \text{ ft.kip} > M_{min} = 36.27 \text{ ft.kip} \rightarrow M_1 = 96.56 \text{ ft.kip} \quad \text{ACI 318-19 (6.6.4.5.4)}$$

$$M_{c1} = \delta M_1 \quad \text{ACI 318-19 (6.6.4.5.1)}$$

$$M_{c1} = 1.00 \times 96.56 = 96.56 \text{ ft.kip}$$

$$M_2 = 107.12 \text{ ft.kip} > M_{2,\min} = 36.27 \text{ ft.kip} \rightarrow M_2 = 107.12 \text{ ft.kip}$$

ACI 318-19 (6.6.4.5.4)

$$M_{c2} = \delta M_2$$

ACI 318-19 (6.6.4.5.1)

$$M_{c2} = 1.00 \times 107.12 = 107.12 \text{ ft.kip}$$

M_{c1} and M_{c2} are considered separately to ensure proper comparison of resulting magnified moments against negative and positive moment capacities of unsymmetrical sections.

A summary of the moment magnification factors and magnified moments for the exterior column for all load combinations using both equation options ACI 318-19 (6.6.4.6.2(a)) and (6.6.4.6.2(b)) to calculate δ_s is provided in the table below for illustration and comparison purposes.

No.	Load Combination	Axial Load, kip	Using ACI 6.6.4.6.2(a)			Using ACI 6.6.4.6.2(b)		
			δ	M_{c1} , ft- kip	M_{c2} , ft- kip	δ	M_{c1} , ft- kip	M_{c2} , ft- kip
1	1.4D	400.4	*	*	*	1	48.0	50.7
2	1.2D + 1.6L + 0.5L _r	426.4	1	61.8	65.2	1	61.8	65.2
3	1.2D + 0.5L + 1.6 L _r	383.6	*	*	*	1	47.6	50.2
4	1.2D + 1.6L _r + 0.8W	366.5	*	*	*	1	80.3	88.9
5	1.2D + 1.6L _r - 0.8W	351.8	*	*	*	1.13	37.9	37.9
6	1.2D + 0.5L + 0.5L _r + 1.0W	381.8	1	97.7	108.4	1	96.6	107.1
7	1.2D + 0.5L + 0.5L _r - 1.0W	363.4	*	*	*	1	34.5	34.5
8	0.9D + 1.0W	266.6	*	*	*	1	78.9	88.5
9	0.9D - 1.0W	248.2	*	*	*	1	23.6	23.6

* Not covered by the reference

For column design ACI 318 requires the second-order moment to first-order moment ratios should not exceed 1.40. If this value is exceeded, the column design needs to be revised.

ACI 318-19 (6.2.5.3)

Table 6 - Second-Order Moment to First-Order Moment Ratios

No.	Load Combination	Using ACI 6.6.4.6.2(a)		Using ACI 6.6.4.6.2(b)	
		$M_{c1}/M_{1(1st)}$	$M_{c2}/M_{2(1st)}$	$M_{c1}/M_{1(1st)}$	$M_{c2}/M_{2(1st)}$
1	1.4D	**	**	1.00*	1.00*
2	1.2D + 1.6L + 0.5L _r	1.00*	1.00*	1.00*	1.00*
3	1.2D + 0.5L + 1.6 L _r	**	**	1.00*	1.00*
4	1.2D + 1.6L _r + 0.8W	**	**	1.03	1.03
5	1.2D + 1.6L _r - 0.8W	**	**	1.13	1.13
6	1.2D + 0.5L + 0.5L _r + 1.0W	1.04	1.04	1.03	1.03
7	1.2D + 0.5L + 0.5L _r - 1.0W	**	**	1.00*	1.00*
8	0.9D + 1.0W	**	**	1.02	1.02
9	0.9D - 1.0W	**	**	1.00*	1.00*

* Cutoff value of M_{min} is applied to $M_{1(1st)}$ and $M_{2(1st)}$ in order to avoid unduly large ratios in cases where $M_{1(1st)}$ and $M_{2(1st)}$ moments are smaller than M_{min} .

** Not covered by the reference

6. Column Design

Based on the factored axial loads and magnified moments considering slenderness effects, the capacity of the assumed column section (18 in. x 18 in. with 8-#6 bars distributed all sides equal) will be checked and confirmed to finalize the design. A column interaction diagram will be generated using strain compatibility analysis, the detailed procedure to develop column interaction diagram can be found in “[Interaction Diagram – Tied Reinforced Concrete Column Design Strength \(ACI 318-19\)](#)” example.

The axial compression capacity ϕP_n for all load combinations will be set equals to P_u , then the moment capacity ϕM_n associated to ϕP_n will be compared with the magnified applied moment M_u . The design check for load combination #6 is shown below for illustration. The rest of the checks for the other load combinations are shown in the following Table.

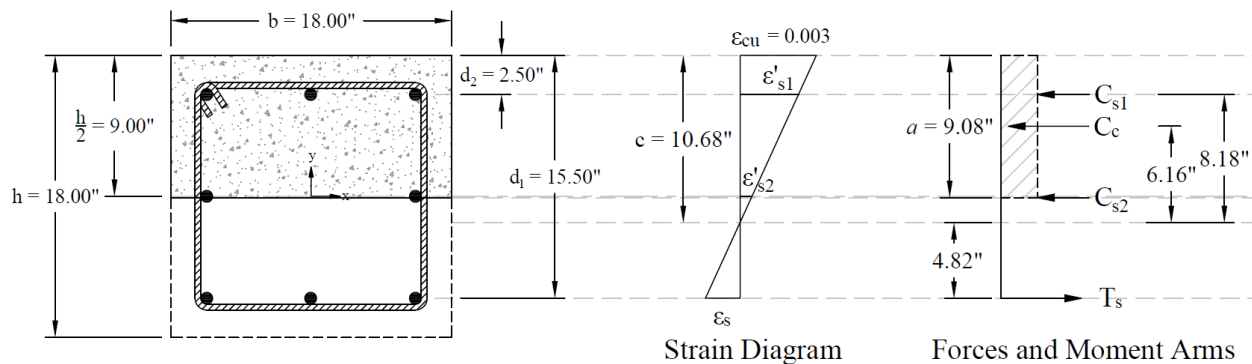

Figure 7 – Strains, Forces, and Moment Arms (Load Combination #6)

The following procedure is used to determine the nominal moment capacity by setting the design axial load capacity, ϕP_n , equal to the applied axial load, P_u and iterating on the location of the neutral axis.

6.1. c , a , and strains in the reinforcement

Try $c = 10.679$ in.

Where c is the distance from the fiber of maximum compressive strain to the neutral axis.

ACI 318-19 (22.2.2.4.2)

$$a = \beta_1 \times c = 0.85 \times 10.679 = 9.077 \text{ in.}$$

ACI 318-19 (22.2.2.4.1)

Where:

$$\beta_1 = 0.85 - \frac{0.05 \times (f'_c - 4000)}{1000} = 0.85 - \frac{0.05 \times (4000 - 4000)}{1000} = 0.85$$

ACI 318-19 (Table 22.2.2.4.3)

$$\epsilon_{cu} = 0.003$$

ACI 318-19 (22.2.2.1)

$$\varepsilon_y = \frac{f_y}{E_s} = \frac{60}{29,000} = 0.00207$$

$$\varepsilon_s = (d_1 - c) \times \frac{0.003}{c} = (15.50 - 10.679) \times \frac{0.003}{10.679} = 0.00135 \text{ (Tension)} < \varepsilon_y$$

\therefore tension reinforcement has not yielded

$$\therefore \phi = 0.65$$

ACI 318-19 (Table 21.2.2)

$$\varepsilon'_{s1} = (c - d_2) \times \frac{0.003}{c} = (10.679 - 2.50) \times \frac{0.003}{10.679} = 0.0023 \text{ (Compression)} > \varepsilon_y$$

$$\varepsilon'_{s2} = \left(c - \frac{h}{2}\right) \times \frac{0.003}{c} = (10.679 - 9.00) \times \frac{0.003}{10.679} = 0.00047 \text{ (Tension)} < \varepsilon_y$$

6.2. Forces in the concrete and steel

$$C_c = 0.85 \times f'_c \times a \times b = 0.85 \times 4,000 \times 9.078 \times 18 = 555.5 \text{ kip}$$

ACI 318-19 (22.2.2.4.1)

$$f_s = \varepsilon_s \times E_s = 0.00135 \times 29,000,000 = 39,276 \text{ psi}$$

$$T_s = f_s \times A_{s1} = 39,276 \times (3 \times 0.44) = 51.8 \text{ kip}$$

Since $\varepsilon'_{s1} > \varepsilon_y \rightarrow$ compression reinforcement has yielded

$$\therefore f'_{s1} = f_y = 60,000 \text{ psi}$$

Since $\varepsilon'_{s2} < \varepsilon_y \rightarrow$ compression reinforcement has not yielded

$$\therefore f'_{s2} = \varepsilon'_{s2} \times E_s = 0.00047 \times 29,000,000 = 13,679 \text{ psi}$$

The area of the reinforcement in this layer has been included in the area (ab) used to compute C_c . As a result, it is necessary to subtract $0.85f'_c$ from f'_s before computing C_s :

$$C_{s1} = (f'_{s1} - 0.85f'_c) \times A'_{s1} = (60,000 - 0.85 \times 4,000) \times (3 \times 0.44) = 74.7 \text{ kip}$$

$$C_{s2} = (f'_{s2} - 0.85f'_c) \times A'_{s2} = (13,679 - 0.85 \times 4,000) \times (2 \times 0.44) = 9.0 \text{ kip}$$

6.3. ϕP_n and ϕM_n

$$P_n = C_c + C_{s1} + C_{s2} - T_s = 555.5 + 74.7 + 9.0 - 51.8 = 587.4 \text{ kip}$$

$$\phi P_n = 0.85 \times 587.4 = 381.8 \text{ kip} = P_u$$

The assumed value of $c = 10.679$ in. is correct.

$$M_n = C_c \times \left(\frac{h}{2} - \frac{a}{2} \right) + C_{s1} \times \left(\frac{h}{2} - d_2 \right) + C_{s2} \times \left(\frac{h}{2} - \frac{h}{2} \right) + T_s \times \left(d_1 - \frac{h}{2} \right)$$

$$M_n = 555.5 \times \left(\frac{18}{2} - \frac{9.077}{2} \right) + 74.7 \times \left(\frac{18}{2} - 2.5 \right) + 9.0 \times \left(\frac{18}{2} - \frac{18}{2} \right) + 51.8 \times \left(15.5 - \frac{18}{2} \right) = 275 \text{ kip.ft}$$

$$\phi M_n = 0.85 \times 275 = 178.81 \text{ kip.ft} > M_u = M_{c2} = 107.1 \text{ kip.ft}$$

No.	P_u , kip	$M_u = M_{2(\text{nd})}$, ft-kip	c, in.	$\varepsilon_t = \varepsilon_s$	ϕ	ϕP_n , kip	ϕM_n , kip.ft
1	400.4	50.7	11.07	0.00120	0.65	400.4	176.5
2	426.4	65.2	11.63	0.00100	0.65	426.4	172.7
3	383.6	50.2	10.72	0.00134	0.65	383.6	178.6
4	366.5	88.9	10.32	0.00150	0.65	366.5	180.8
5	351.8	33.4	10.02	0.00164	0.65	351.8	182.3
6	381.8	107.1	10.68	0.00135	0.65	381.8	178.8
7	363.4	34.5	10.26	0.00153	0.65	363.4	181.1
8	266.6	88.5	7.24	0.00342	0.76	266.6	203.7
9	248.2	23.6	6.64	0.00401	0.81	248.2	208.6

Since $\phi M_n > M_u$ for all $\phi P_n = P_u$, use 18 x 18 in. column with 8-#6 bars.

7. Column Interaction Diagram - spColumn Software

[spColumn](#) is a StructurePoint software program that performs the analysis and design of reinforced concrete sections subjected to axial force combined with uniaxial or biaxial bending. Using the provisions of the Strength Design Method and Unified Design Provisions, slenderness considerations are used for moment magnification due to second order effect (P-Delta) for sway and non-sway frames.

For this column section, investigation mode is used, service loads are defined, and slenderness effects are considered using ACI 318-19 provisions. The model input parameters, results, and report (for load combination #6) are shown below.

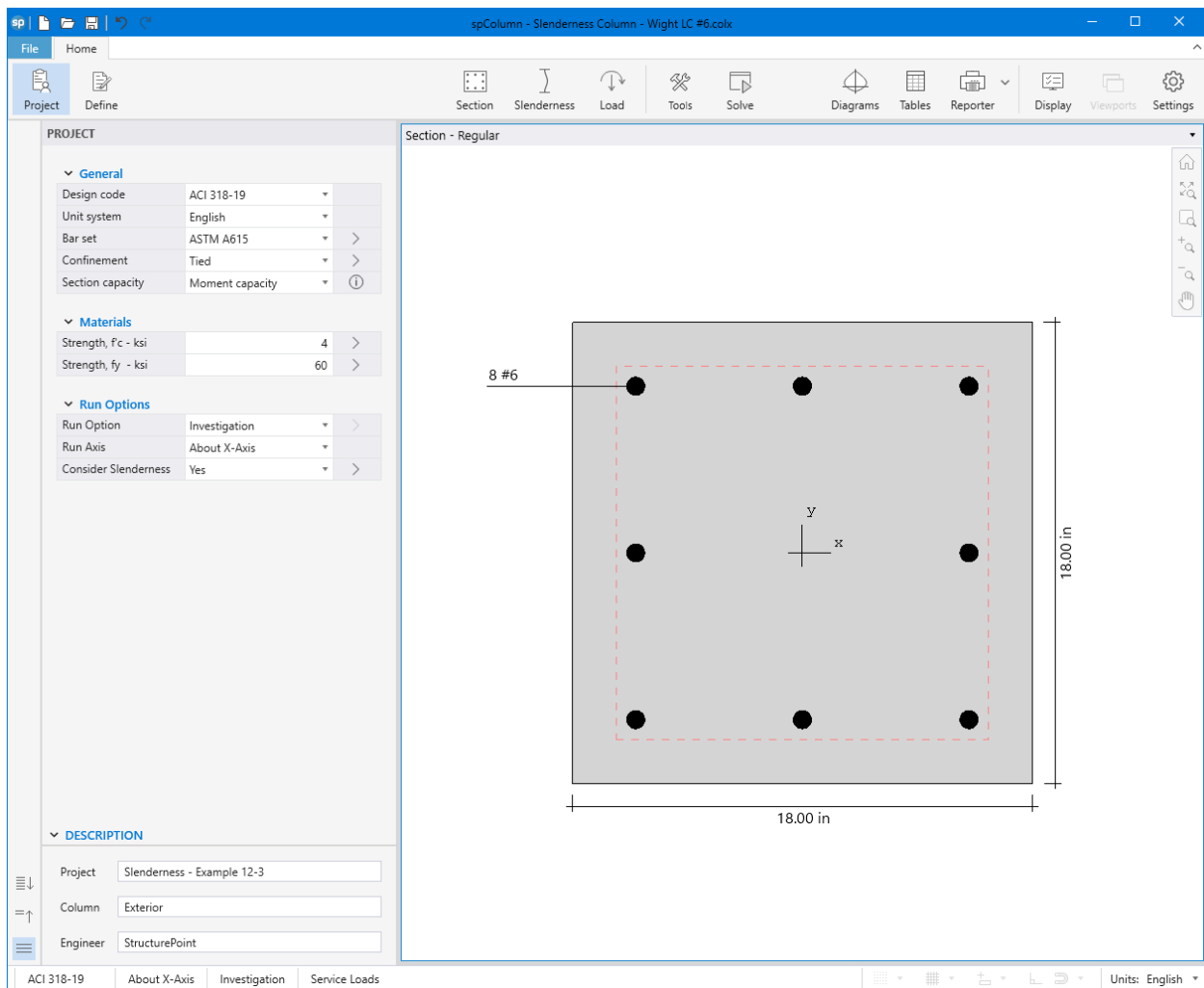

Figure 8 – spColumn Interface

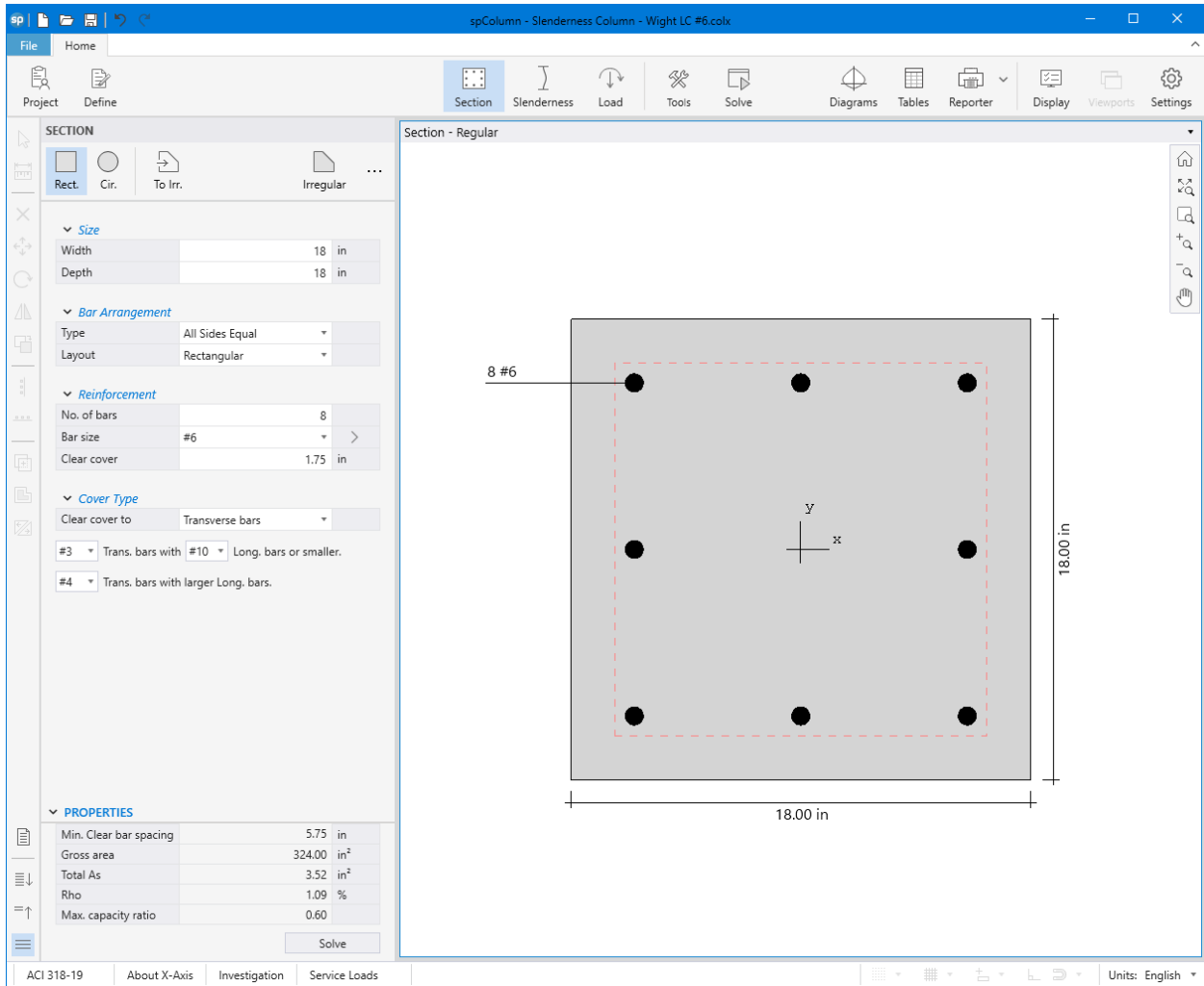

Figure 9 – spColumn Model Editor

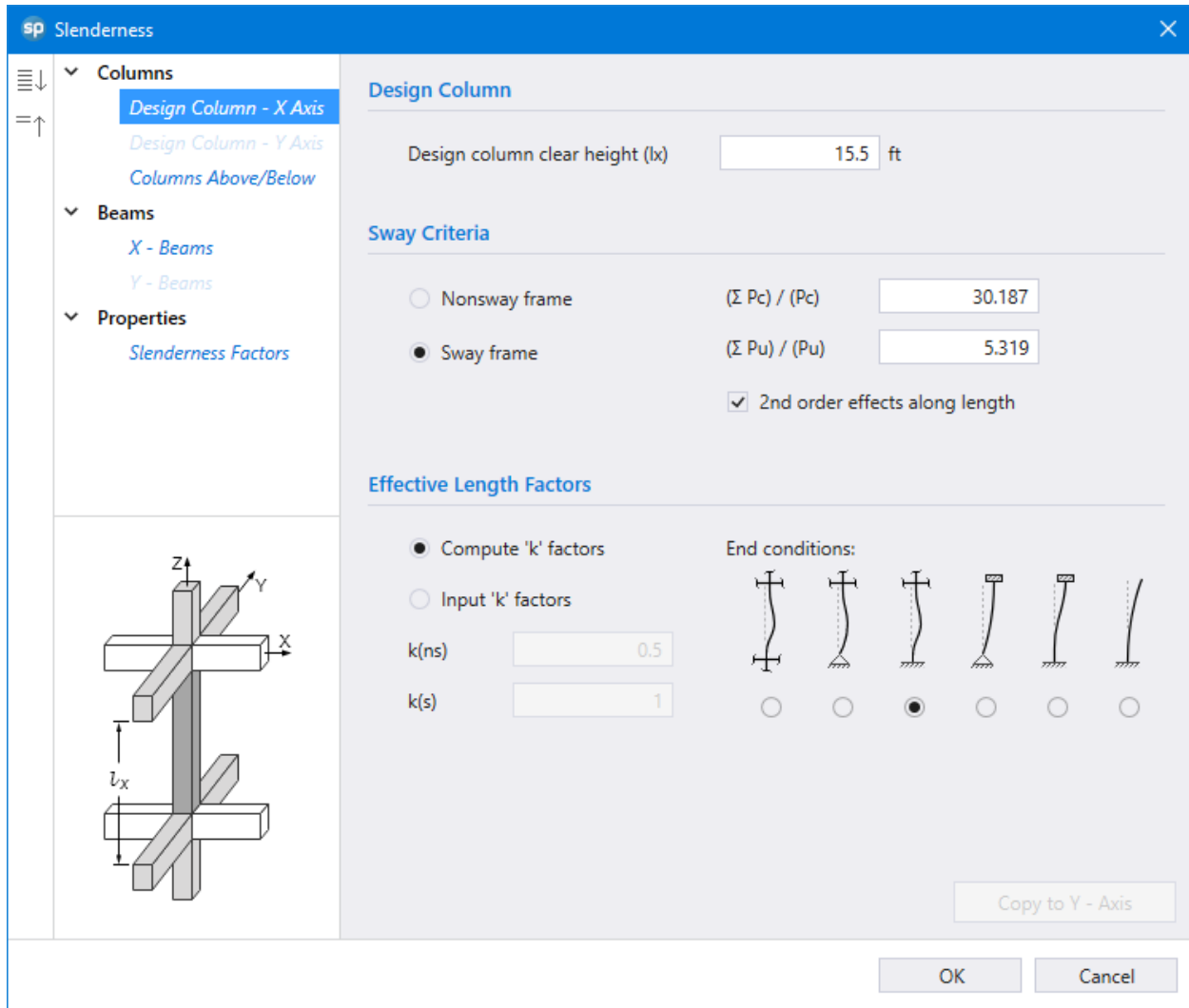

Figure 10 – Defining Slenderness – Load Combination #6 (spColumn)

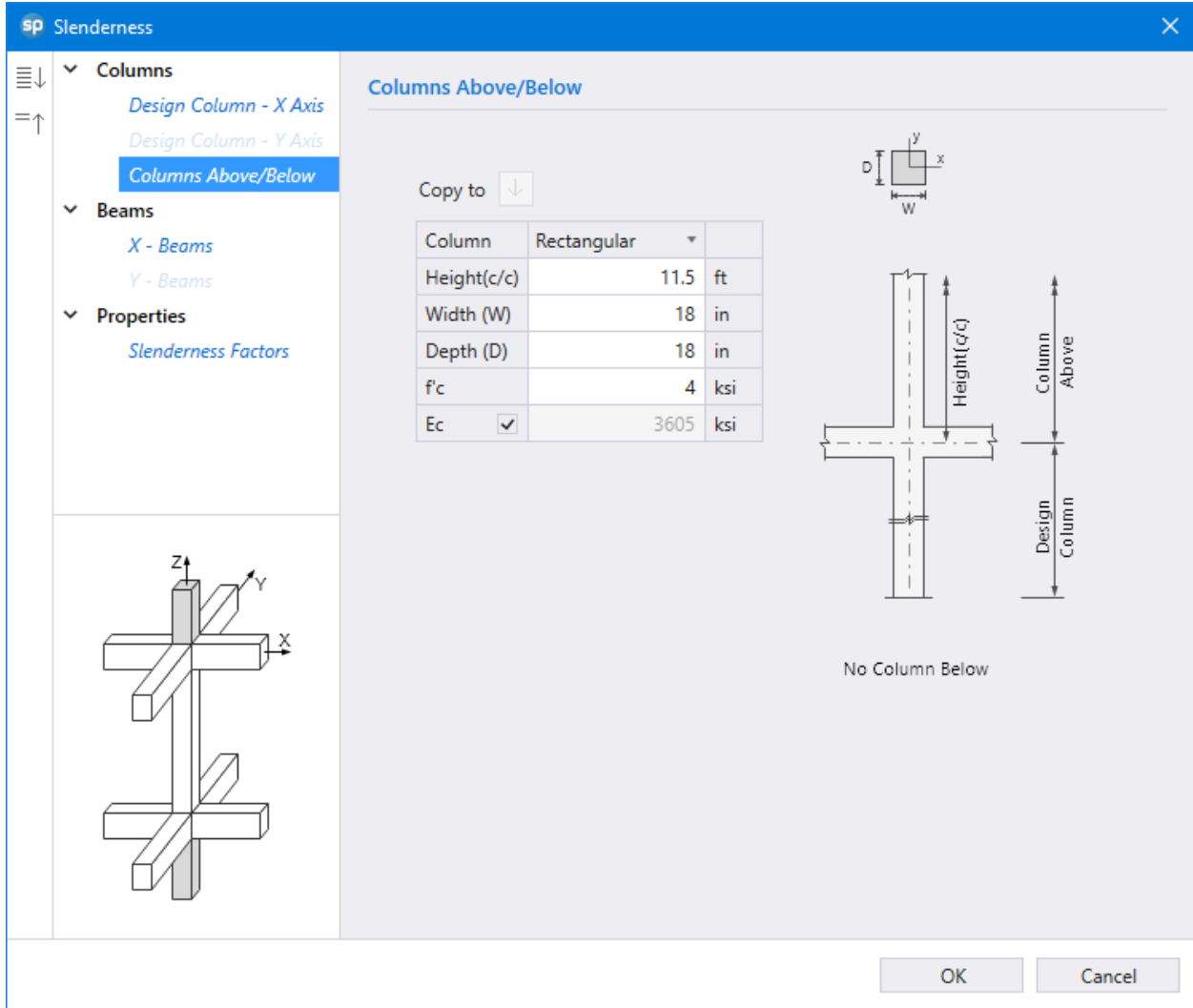

Figure 11 – Defining Columns Above / Below (spColumn)

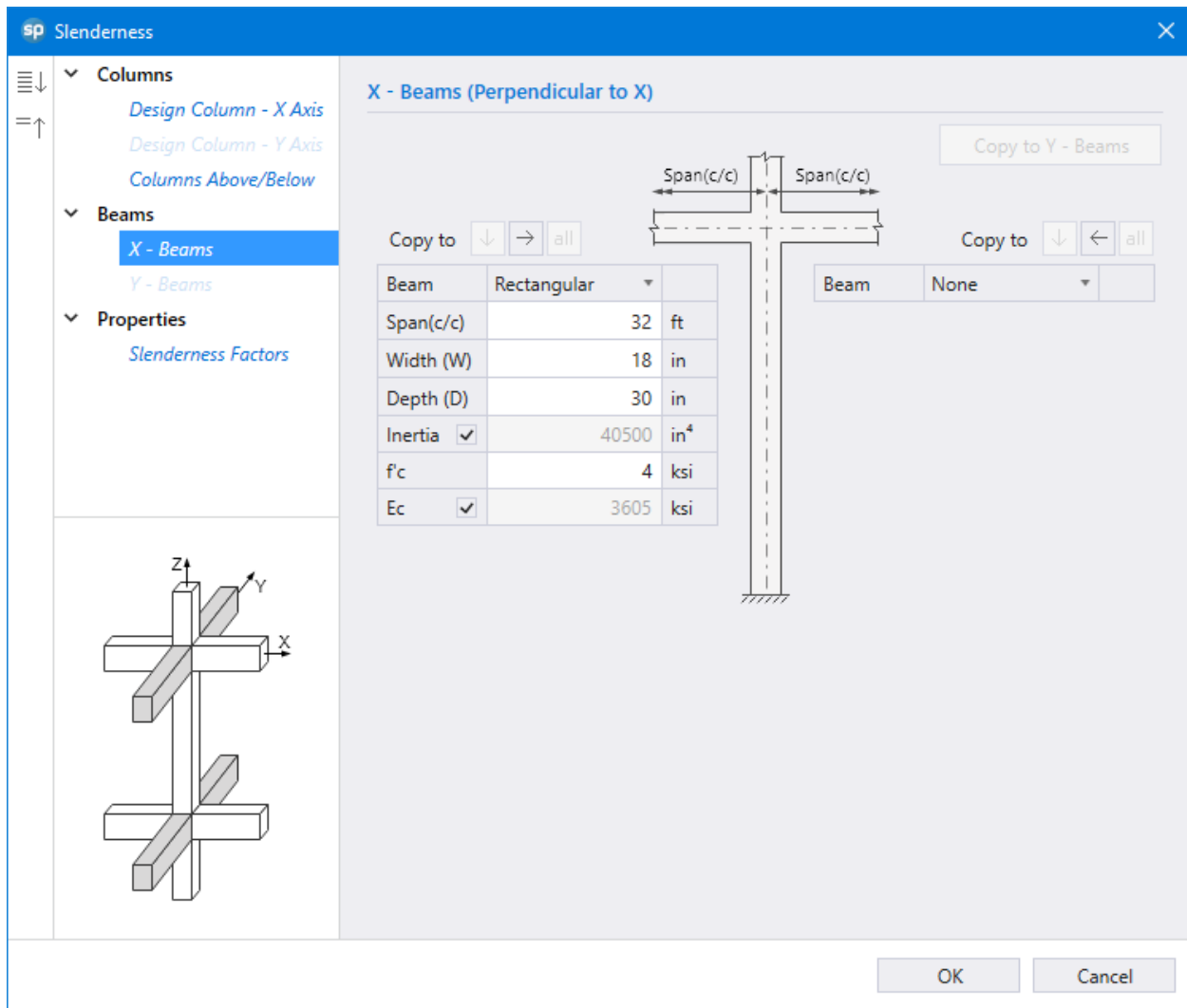

Figure 12 – Defining Beams in X-Direction (spColumn)

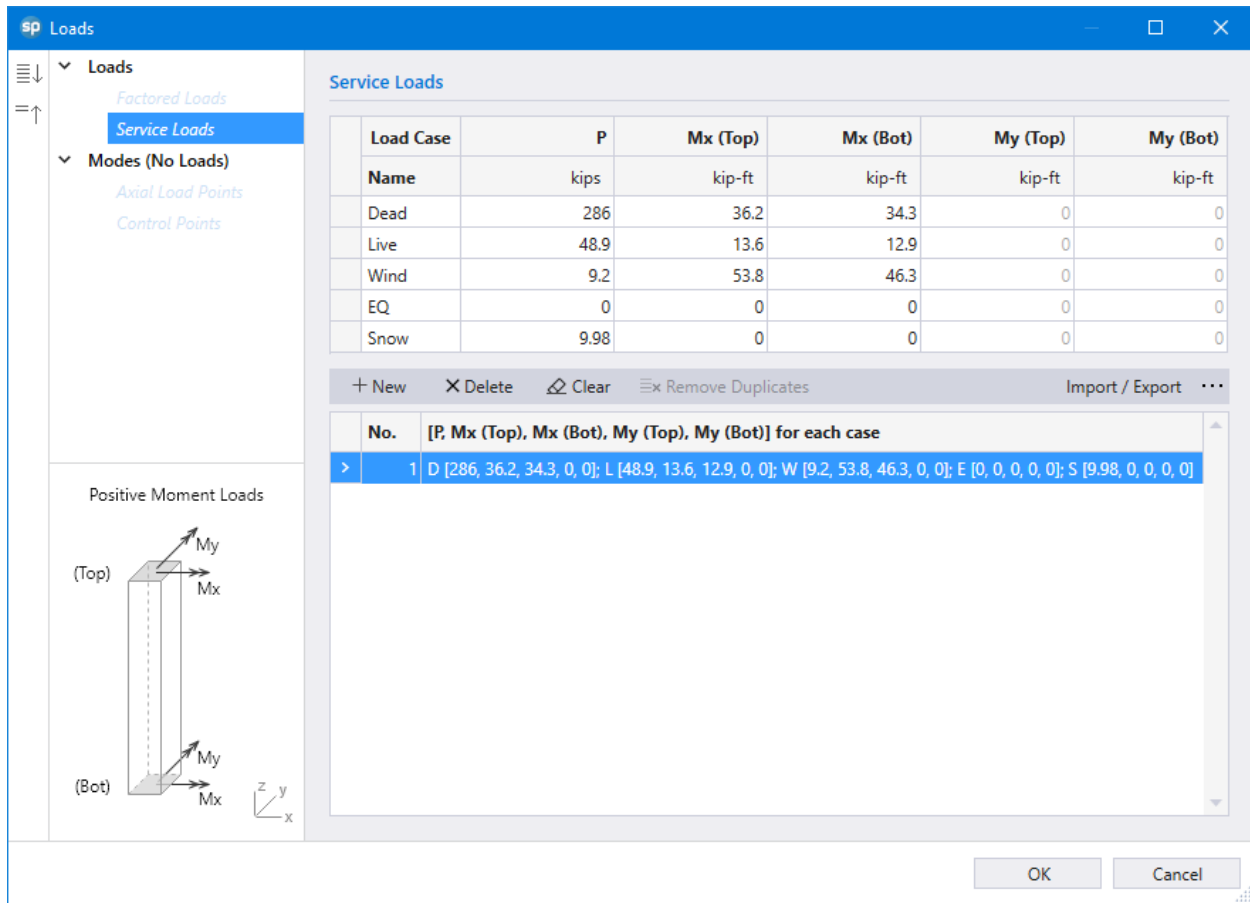

Figure 13 – Defining Loads / Modes (spColumn)

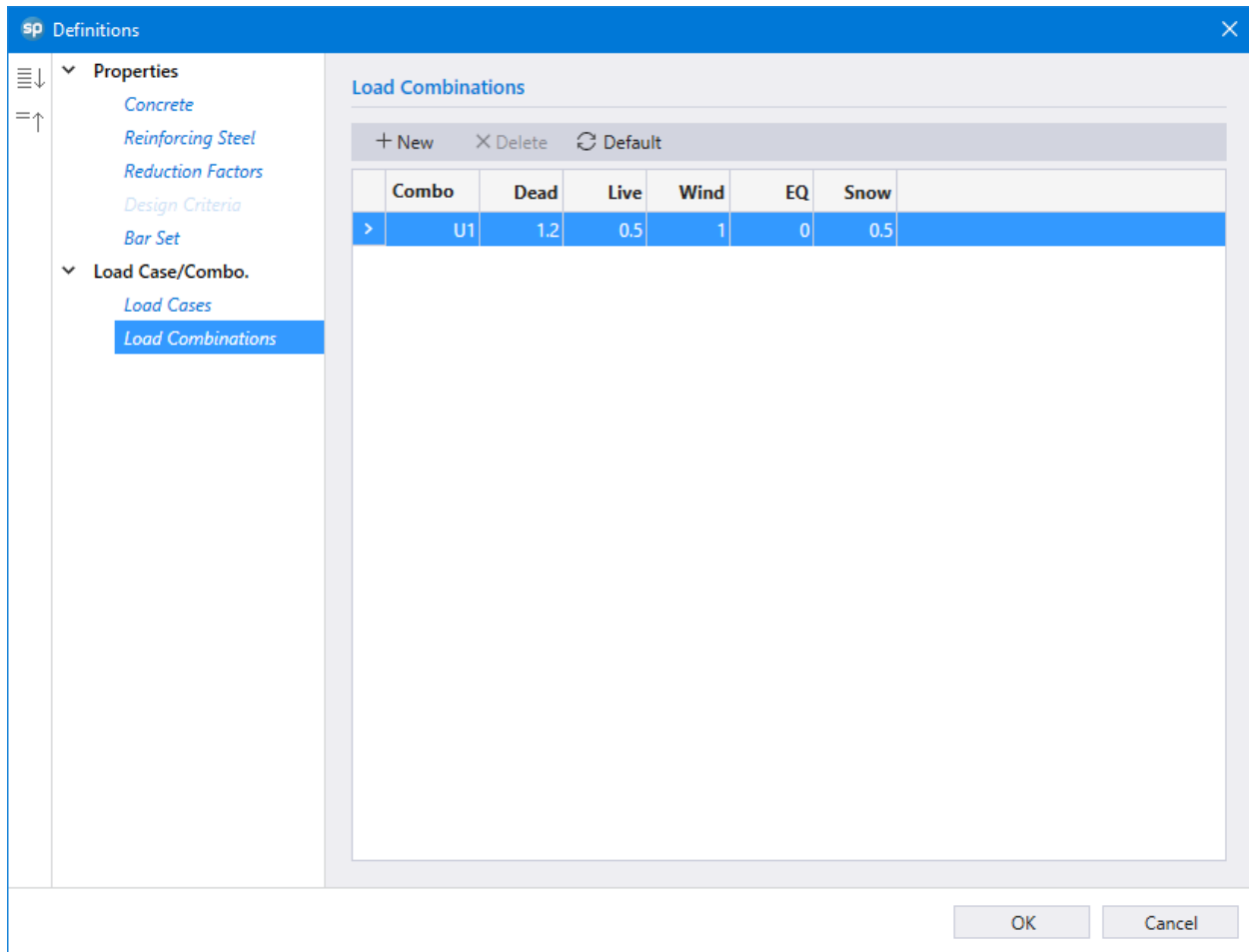

Figure 14 – Defining Load Combination #6 (spColumn)

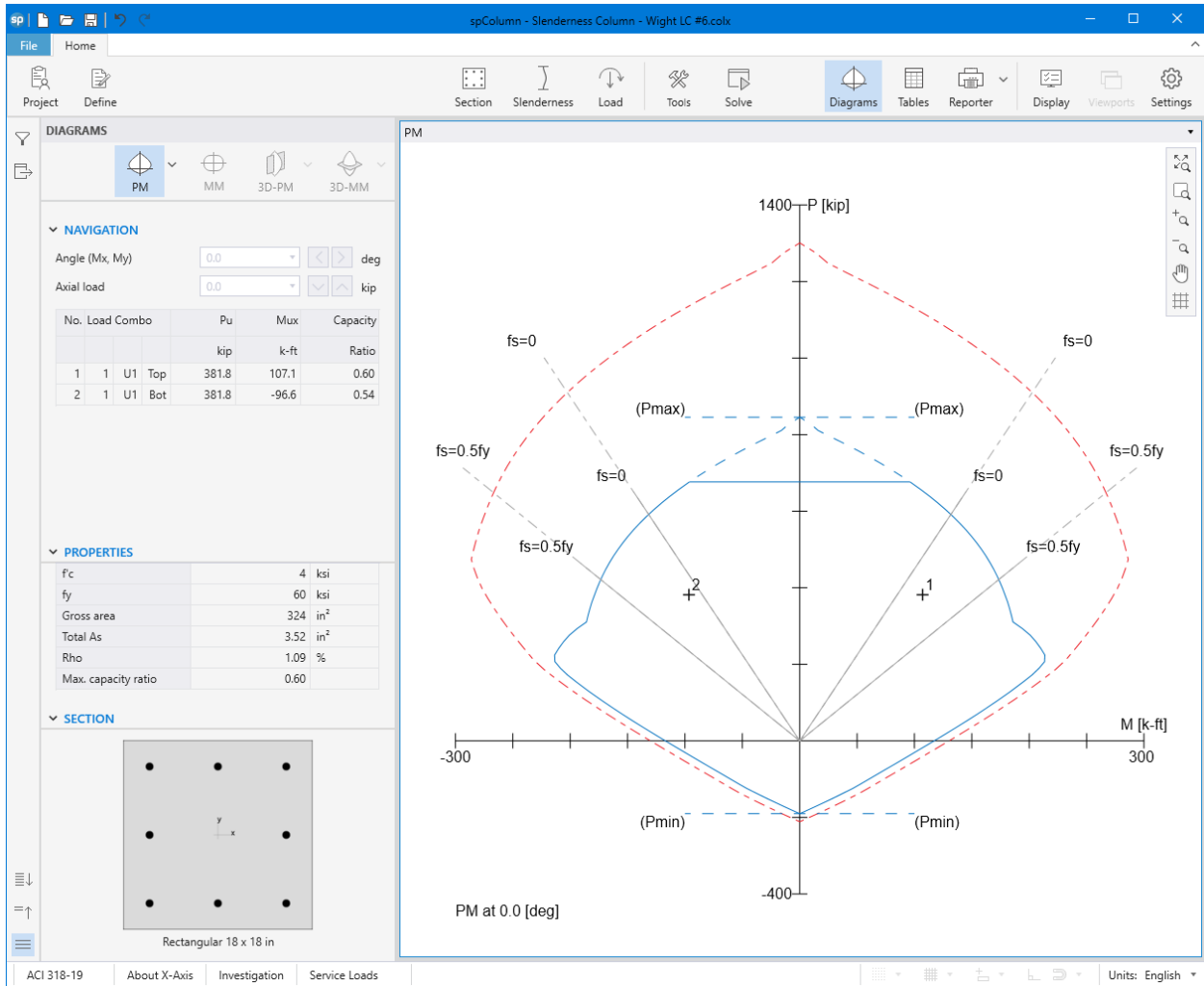
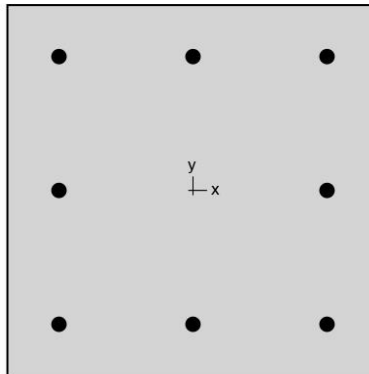

Figure 15 – Column Section Interaction Diagram about X-Axis – Design Check for Load Combination #6 (spColumn)



spColumn v10.00 (TM)
Computer program for the Strength Design of Reinforced Concrete Sections
Copyright - 1988-2021, STRUCTUREPOINT, LLC.
All rights reserved



StructurePoint
Licensee stated below acknowledges that STRUCTUREPOINT (SP) is not and cannot be responsible for either the accuracy or adequacy of the material supplied as input for processing by the spColumn computer program. Furthermore, STRUCTUREPOINT neither makes any warranty expressed nor implied with respect to the correctness of the output prepared by the spColumn program. Although STRUCTUREPOINT has endeavored to produce spColumn error free the program is not and cannot be certified infallible. The final and only responsibility for analysis, design and engineering documents is the licensee's. Accordingly, STRUCTUREPOINT disclaims all responsibility in contract, negligence or other tort for any analysis, design or engineering documents prepared in connection with the use of the spColumn program. Licensed to: StructurePoint, LLC. License ID: 00000-0000000-4-20FC1-20FC1

Contents

1. General Information	3
2. Material Properties	3
2.1. Concrete	3
2.2. Steel	3
3. Section	3
3.1. Shape and Properties	3
3.2. Section Figure	4
4. Reinforcement	4
4.1. Bar Set: ASTM A615	4
4.2. Confinement and Factors	4
4.3. Arrangement	4
5. Loading	5
5.1. Load Cases	5
5.2. Load Combinations	5
5.3. Service Loads	5
6. Slenderness	5
6.1. Sway Criteria	5
6.2. Columns	5
6.3. X - Beams	5
7. Moment Magnification	6
7.1. General Parameters	6
7.2. Effective Length Factors	6
7.3. Magnification Factors: X - axis	6
8. Factored Moments	6
8.1. X - axis	6
9. Control Points	6
10. Factored Loads and Moments with Corresponding Capacity Ratios	7
11. Diagrams	8
11.1. PM at $\theta=0$ [deg]	8

List of Figures

Figure 1: Column section	4
--------------------------------	---

STRUCTUREPOINT - spColumn v10.00 (TM)
Licensed to: StructurePoint, LLC. License ID: 00000-0000000-4-20FC1-20FC1
E:\StructurePoint\spColumn\Slenderness Column - Wight LC #6.colx

Page | 3
8/11/2022
3:11 PM

1. General Information

File Name	E:\Struc...\Slenderness Column - Wight LC #6.colx
Project	Slenderness - Example 12-3
Column	Exterior
Engineer	StructurePoint
Code	ACI 318-19
Bar Set	ASTM A615
Units	English
Run Option	Investigation
Run Axis	X - axis
Slenderness	Considered
Column Type	Structural
Capacity Method	Moment capacity

2. Material Properties

2.1. Concrete

Type	Standard
f'_c	4 ksi
E_c	3605 ksi
f_c	3.4 ksi
ϵ_u	0.003 in/in
β_1	0.85

2.2. Steel

Type	Standard
f_y	60 ksi
E_s	29000 ksi
ϵ_y	0.00206897 in/in

3. Section

3.1. Shape and Properties

Type	Rectangular
Width	18 in
Depth	18 in
A_g	324 in ²
I_x	8748 in ⁴
I_y	8748 in ⁴
r_x	5.19615 in
r_y	5.19615 in
X_o	0 in
Y_o	0 in

3.2. Section Figure

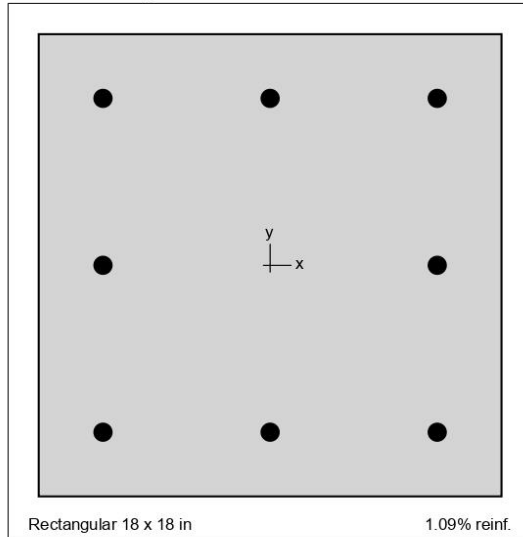

Figure 1: Column section

4. Reinforcement

4.1. Bar Set: ASTM A615

Bar	Diameter in	Area in ²	Bar	Diameter in	Area in ²	Bar	Diameter in	Area in ²
#3	0.38	0.11	#4	0.50	0.20	#5	0.63	0.31
#6	0.75	0.44	#7	0.88	0.60	#8	1.00	0.79
#9	1.13	1.00	#10	1.27	1.27	#11	1.41	1.56
#14	1.69	2.25	#18	2.26	4.00			

4.2. Confinement and Factors

Confinement type	Tied
For #10 bars or less	#3 ties
For larger bars	#4 ties
Capacity Reduction Factors	
Axial compression, (a)	0.8
Tension controlled ϕ , (b)	0.9
Compression controlled ϕ , (c)	0.65

4.3. Arrangement

Pattern	All sides equal
Bar layout	Rectangular
Cover to	Transverse bars
Clear cover	1.75 in
Bars	8 #6

STRUCTUREPOINT - spColumn v10.00 (TM)
Licensed to: StructurePoint, LLC. License ID: 00000-0000000-4-20FC1-20FC1
E:\StructurePoint\spColumn\Slenderness Column - Wight LC #6.colx

Page | 5
8/11/2022
3:11 PM

Total steel area, A_s	3.52 in ²
Rho	1.09 %
Minimum clear spacing	5.75 in

5. Loading

5.1. Load Cases

Case	Type	Sustained Load %
A	Dead	100
B	Live	0
C	Wind	0
D	EQ	0
E	Snow	0

5.2. Load Combinations

Combination	Dead	Live	Wind	EQ	Snow
U1	1.200	0.500	1.000	0.000	0.500

5.3. Service Loads

No.	Load Case	Axial Load kip	Mx @ Top k-ft	Mx @ Bottom k-ft	My @ Top k-ft	My @ Bottom k-ft
1	Dead	286.00	36.20	34.30	0.00	0.00
1	Live	48.90	13.60	12.90	0.00	0.00
1	Wind	9.20	53.80	46.30	0.00	0.00
1	EQ	0.00	0.00	0.00	0.00	0.00
1	Snow	9.98	0.00	0.00	0.00	0.00

6. Slenderness

6.1. Sway Criteria

X-Axis	Sway column
2 nd order effects along length	Considered
ΣP_c	30.19 x P_c
ΣP_u	5.32 x P_u

6.2. Columns

Column	Axis	Height ft	Width in	Depth/Dia. in	I in ⁴	f_c ksi	E_c ksi
Design	X	15.5	18	18	8748	4	3605
Above	X	11.5	18	18	8748	4	3605
Below	X	(no column specified...)					

6.3. X - Beams

Beam	Length ft	Width in	Depth in	I in ⁴	f_c ksi	E_c ksi
Above Left	32	18	30	40500	4	3605
Above Right	(no beam specified...)					
Below Left	Rigid beam					
Below Right	Rigid beam					

STRUCTUREPOINT - spColumn v10.00 (TM)
Licensed to: StructurePoint, LLC. License ID: 00000-0000000-4-20FC1-20FC1
E:\StructurePoint\spColumn\Slenderness Column - Wight LC #6.colx

Page | 6
8/11/2022
3:11 PM

7. Moment Magnification

7.1. General Parameters

Factors	Code defaults
Stiffness reduction factor, ϕ_k	0.75
Cracked section coefficients, c_l (beams)	0.35
Cracked section coefficients, c_l (columns)	0.7
$0.2 E_c I_g + E_s I_{se}$ (X-axis)	9.54e+006 kip-in ²
Minimum eccentricity, $e_{x,min}$	1.14 in

7.2. Effective Length Factors

Axis	Ψ_{top}	Ψ_{bottom}	k (Nonsway)	k (Sway)	kl_u/r
X	2.027	0.000	0.656	1.282	45.90

7.3. Magnification Factors: X - axis

Load Combo	At Ends					Along Length					
	ΣP_u kip	P_e kip	ΣP_e kip	β_{ds}	δ_s	P_u kip	$k'l_u/r$	P_e kip	β_{dns}	C_m	δ
1 U1	2031.01	1655.66	49979.48	0.000	1.057	381.84	(N/A)	3331.44	0.899	0.239	1.000

8. Factored Moments

NOTE: Each loading combination includes the following cases:
Top - At column top
Bot - At column bottom

8.1. X - axis

Load Combo	1 st Order				2 nd Order		Ratio 2 nd /1 st
	M_{ns} k-ft	M_s k-ft	M_u k-ft	M_{min} k-ft	M_1 k-ft	M_c k-ft	
1 U1 Top	50.24	53.80	104.04	36.27	$M_2=$ 107.12	107.12	1.030
1 U1 Bot	-47.61	-46.30	-93.91	-36.27	$M_1=$ -96.56	-96.56	1.028

9. Control Points

About Point	P kip	X-Moment k-ft	Y-Moment k-ft	NA Depth in	d_c Depth in	ϵ_t	ϕ
X @ Max compression	845.5	0.00	0.00	49.94	15.50	-0.00207	0.65000
X @ Allowable comp.	676.4	96.14	0.00	17.64	15.50	-0.00036	0.65000
X @ $f_s = 0.0$	591.6	131.67	0.00	15.50	15.50	0.00000	0.65000
X @ $f_s = 0.5 f_y$	421.5	173.45	0.00	11.53	15.50	0.00103	0.65000
X @ Balanced point	308.2	186.05	0.00	9.17	15.50	0.00207	0.65000
X @ Tension control	214.3	215.41	0.00	5.76	15.50	0.00507	0.90000
X @ Pure bending	0.0	117.01	0.00	2.52	15.50	0.01545	0.90000
X @ Max tension	-190.1	0.00	0.00	0.00	15.50	9.99999	0.90000
-X @ Max compression	845.5	0.00	0.00	49.94	15.50	-0.00207	0.65000
-X @ Allowable comp.	676.4	-96.14	0.00	17.64	15.50	-0.00036	0.65000
-X @ $f_s = 0.0$	591.6	-131.67	0.00	15.50	15.50	0.00000	0.65000
-X @ $f_s = 0.5 f_y$	421.5	-173.45	0.00	11.53	15.50	0.00103	0.65000
-X @ Balanced point	308.2	-186.05	0.00	9.17	15.50	0.00207	0.65000
-X @ Tension control	214.3	-215.41	0.00	5.76	15.50	0.00507	0.90000
-X @ Pure bending	0.0	-117.01	0.00	2.52	15.50	0.01545	0.90000
-X @ Max tension	-190.1	0.00	0.00	0.00	15.50	9.99999	0.90000

STRUCTUREPOINT - spColumn v10.00 (TM)
Licensed to: StructurePoint, LLC. License ID: 00000-0000000-4-20FC1-20FC1
E:\StructurePoint\spColumn\Slenderness Column - Wight LC #6.colx

Page | 7
8/11/2022
3:11 PM

10. Factored Loads and Moments with Corresponding Capacity Ratios

NOTE: Calculations are based on "Moment Capacity" Method.

Each loading combination includes the following cases:

Top - At column top

Bot - At column bottom

No.	Load Combo	Demand		Capacity		Parameters at Capacity			Capacity Ratio
		P_u kip	M_{ux} k-ft	ϕP_n kip	ϕM_{nx} k-ft	NA Depth in	ϵ_t	ϕ	
1	1 U1 Top	381.84	107.12	381.84	178.80	10.68	0.00135	0.650	0.60
2	1 U1 Bot	381.84	-96.56	381.84	-178.80	10.68	0.00135	0.650	0.54

11. Diagrams

11.1. PM at $\theta=0$ [deg]

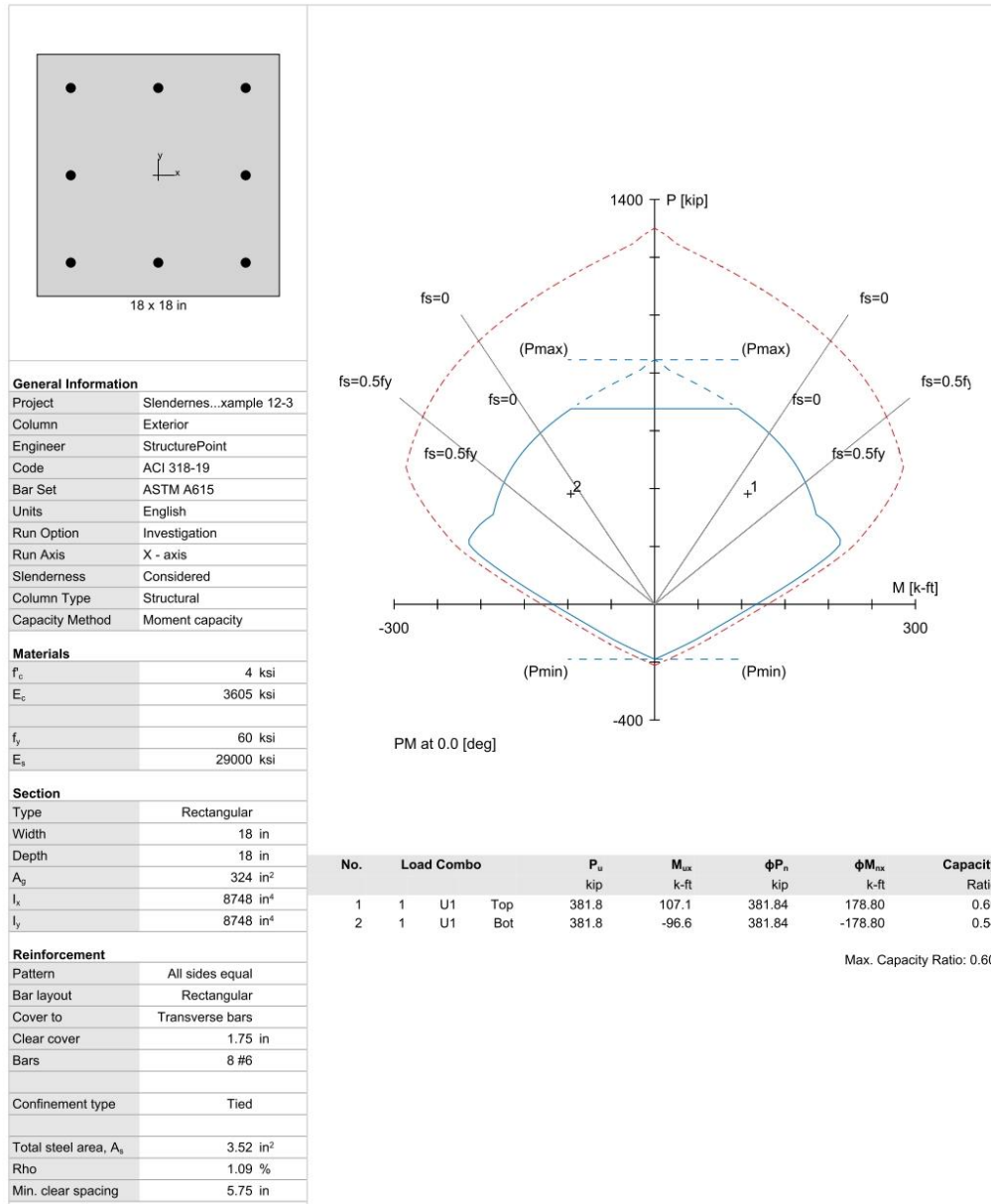

8. Summary and Comparison of Design Results

Analysis and design results from the hand calculations above are compared for the one load combination used in the reference (Example 12-3) and exact values obtained from [spColumn](#) model.

Table 8 – Parameters for Moment Magnification along the Column Length									
	Q	k	β_{dns}	C_m	I_{se}	P_c , kip	δ	$M_{2(min)}$, ft-kip	$M_{2(2nd)}$, ft-kip
Load Combination #2									
Hand	0.085	0.66*	0.81	0.221	111.5 [‡]	3,504	1 > 0.264	40.5	65.2
Reference	0.085	1.00 [†]	0.81	0.220	150.0 [†]	1,680	1 > 0.330	40.5	65.2
spColumn	---	0.66 [‡]	0.81	0.221	111.5 [‡]	3,505	1 > 0.264	40.5	65.2
Load Combination #6									
Hand	0.076	0.66*	0.90	0.239	111.5 [‡]	3,331	1 > 0.283	36.3	107.1
Reference	0.076	---	---	---	---	---	---	---	107.0
spColumn	---	0.66 [‡]	0.90	0.239	111.5 [‡]	3,331	1 > 0.282	36.3	107.1
* From nomographs (ACI 318 charts)									
† Conservatively estimated not using exact formula without impact on the final results in this special case									
‡ Exact formulated answer									

In this table, a detailed comparison for all considered load combinations are presented for comparison.

Table 9 - Factored Axial loads and Magnified Moments at Column Ends										
No.	P_u , kip		k_s		δ_s		$M_{1(2nd)}$, ft-kip		$M_{2(2nd)}$, ft-kip	
	Hand	spColumn	Hand	spColumn	Hand	spColumn	Hand	spColumn	Hand	spColumn
1	400.4	400.4	1.282	1.282	1.06	1.06	48.0	48.0	50.7	50.7
2	426.4	426.4	1.282	1.282	1.07	1.07	61.8	61.8	65.2	65.2
3	383.6	383.6	1.282	1.282	1.06	1.06	47.6	47.6	50.2	50.2
4	366.5	366.5	1.282	1.282	1.06	1.06	80.2	80.3	88.9	88.9
5	351.8	351.8	1.282	1.282	1.05	1.05	2.1	2.1	-1.9	-1.9
6	381.8	381.8	1.282	1.282	1.06	1.06	96.6	96.6	107.1	107.1
7	363.4	363.4	1.282	1.282	1.06	1.06	-1.3	-1.3	-6.6	-6.6
8	266.6	266.6	1.282	1.282	1.04	1.04	79.0	79.0	88.5	88.5
9	248.2	248.2	1.282	1.282	1.04	1.04	-17.2	-17.2	-23.3	-23.3

Table 10 - Factored Axial loads and Magnified Moments along Column Length

No.	k_{ns}		δ		M_{c1} , ft-kip		M_{c2} , ft-kip		$M_{c1}/M_{1(1st)}$		$M_{c2}/M_{2(1st)}$	
	Hand	spColumn	Hand	spColumn	Hand	spColumn	Hand	spColumn	Hand	spColumn	Hand	spColumn
1	0.656	0.656	1.00	1.00	48.0	48.0	50.7	50.7	1.00	1.00	1.00	1.00
2	0.656	0.656	1.00	1.00	61.8	61.8	65.2	65.2	1.00	1.00	1.00	1.00
3	0.656	0.656	1.00	1.00	47.6	47.6	50.2	50.2	1.00	1.00	1.00	1.00
4	0.656	0.656	1.00	1.00	80.2	80.3	88.9	88.9	1.03	1.03	1.03	1.03
5	0.656	0.656	1.13	1.13	37.9	37.9	37.9	37.9	1.13	1.13	1.13	1.13
6	0.656	0.656	1.00	1.00	96.6	96.6	107.1	107.1	1.03	1.03	1.03	1.03
7	0.656	0.656	1.00	1.00	34.5	34.5	34.5	34.5	1.00	1.00	1.00	1.00
8	0.656	0.656	1.00	1.00	79.0	79.0	88.5	88.5	1.02	1.02	1.02	1.02
9	0.656	0.656	1.00	1.00	23.6	23.6	23.6	23.6	1.00	1.00	1.00	1.00

Table 11 - Design Parameters Comparison

No.	c, in.		$\epsilon_t = \epsilon_s$		ϕ		ϕP_n , kip		ϕM_n , kip.ft	
	Hand	spColumn	Hand	spColumn	Hand	spColumn	Hand	spColumn	Hand	spColumn
1	11.07	11.07	0.00120	0.00120	0.65	0.65	400.4	400.4	176.5	176.5
2	11.63	11.63	0.00100	0.00100	0.65	0.65	426.4	426.4	172.7	172.7
3	10.72	10.72	0.00134	0.00134	0.65	0.65	383.6	383.6	178.6	178.6
4	10.32	10.32	0.00150	0.00150	0.65	0.65	366.5	366.5	180.8	180.8
5	10.02	10.02	0.00164	0.00164	0.65	0.65	351.8	351.8	182.3	182.3
6	10.68	10.68	0.00135	0.00135	0.65	0.65	381.8	381.8	178.8	178.8
7	10.26	10.26	0.00153	0.00153	0.65	0.65	363.4	363.4	181.1	181.1
8	7.24	7.24	0.00342	0.00342	0.76	0.76	266.6	266.6	203.7	203.7
9	6.64	6.64	0.00401	0.00401	0.81	0.81	248.2	248.2	208.6	208.6

All the results of the hand calculations illustrated above are in precise agreement with the automated exact results obtained from the [spColumn](#) program.

9. Conclusions & Observations

The analysis of the reinforced concrete section performed by [spColumn](#) conforms to the provisions of the Strength Design Method and Unified Design Provisions with all conditions of strength satisfying the applicable conditions of equilibrium and strain compatibility and includes slenderness effects using moment magnification method for sway and nonsway frames.

ACI 318 provides multiple options for calculating values of k , $(EI)_{eff}$, δ_s , and δ leading to variability in the determination of the adequacy of a column section. Engineers must exercise judgment in selecting suitable options to match their design condition as is the case in the reference where the author conservatively made assumptions to simplify and speed the calculation effort. The [spColumn](#) program utilizes the exact methods whenever possible and allows user to override the calculated values with direct input based on their engineering judgment wherever it is permissible.